

# RHIMEX.com

Profiles of rubber, sponge rubber,  
silicone, foam silicone

## **angle profiles**

# AP

# Solid rubber

## Legend

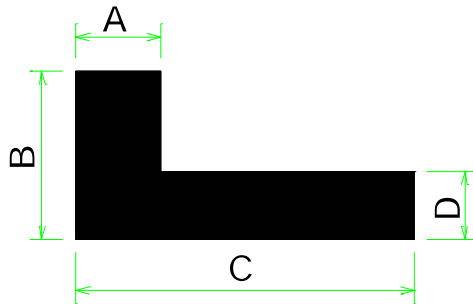

9999

means

Profile-No.

EP / s / 9999 / (9998)

means Quality / Colour / Article-No. / (Article-No. with sa)

sa = self adhesive

### Quality

CR	Neoprene
EP	EPDM
NBR	Perbunan
NK	Natural rubber
Si	Silicone
SPS	Foam silicone
FPM	VITON®
PVC	Soft-PVC
EVA	Ethylenvinylacetat
SBR	Buna (Styrol-Butadien)
-FR	fire resistant

### Colours

s	black
g	grey
w	white
az	anthracite
bg	beige
br	brown
hg	light-grey
rb	red-brown
t	translucent
r	red
x	colour selectable

® = Entered registered trade mark of the company DuPont

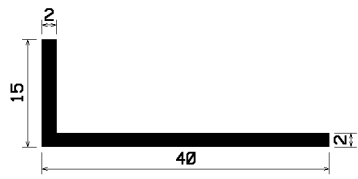

249  
EP/s/ 1739

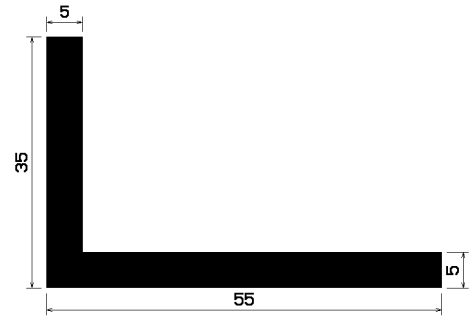

334  
EP/s/ 1740

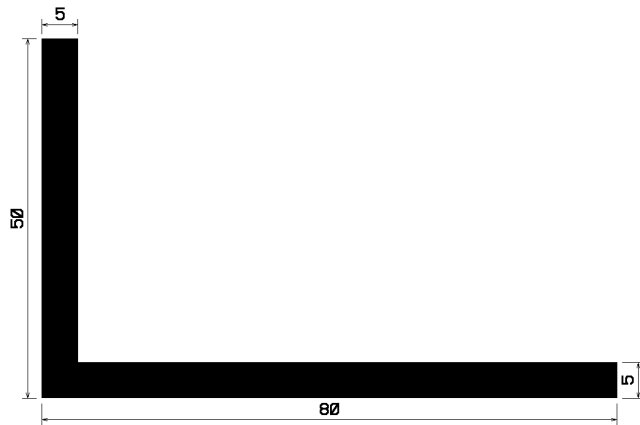

344  
EP/s/ 1741

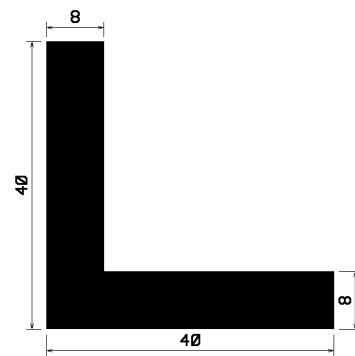

500  
EP/s/ 1744

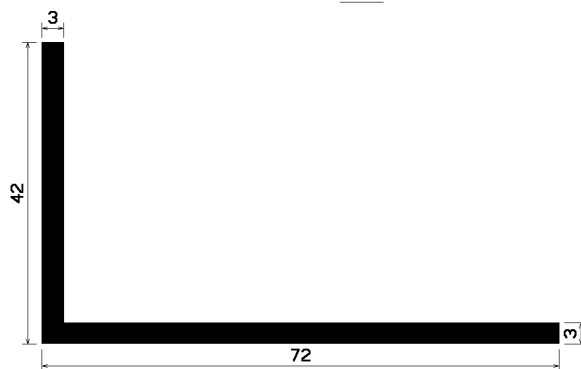

626  
EP/s/ 2078

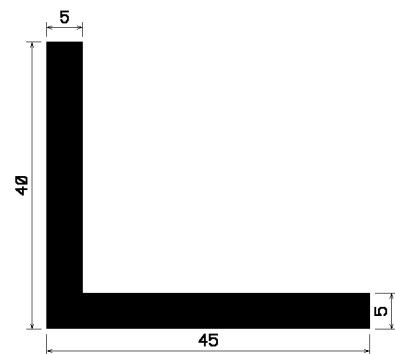

660  
EP/s/ 1745

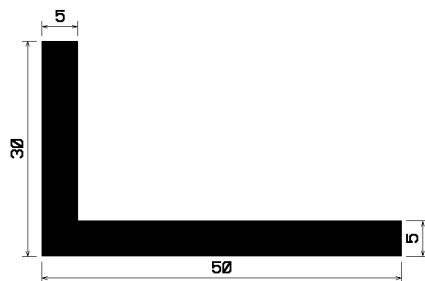

677  
EP/s/ 2079

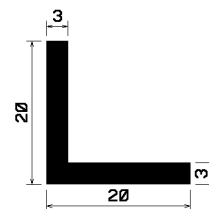

678  
SBR/s/ 2080

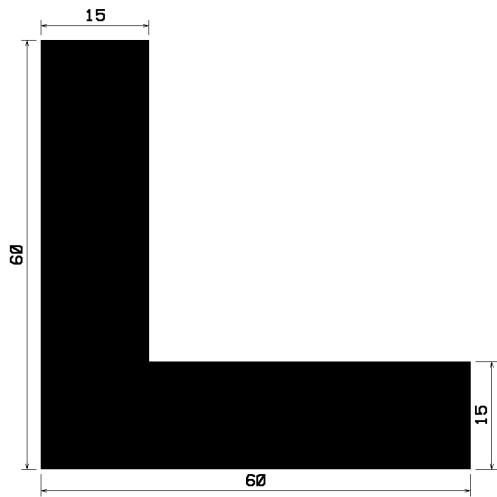

682  
EP/s/ 2081

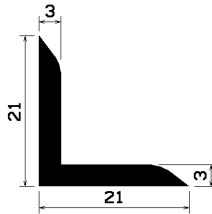

683  
EP/s/ 2082

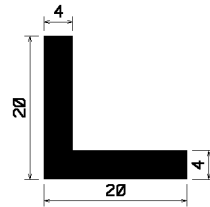

684  
NBR/s/2083

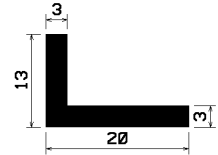

685  
EP/s/ 4058  
NK/w/2084

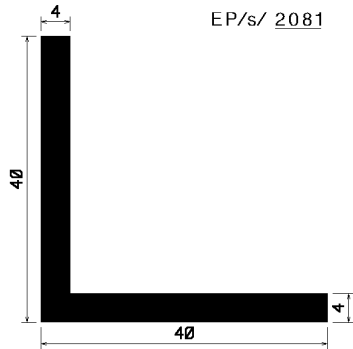

686  
EP/s/ 2085

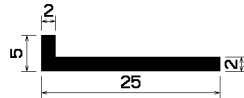

687  
CR/s/2086

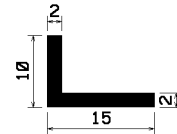

688  
EP/s/ 2087/(4870)

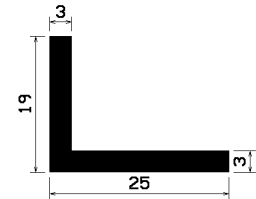

691  
EP/s/ 2905/(5098)

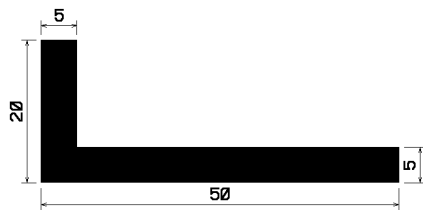

747  
EP/s/ 2194

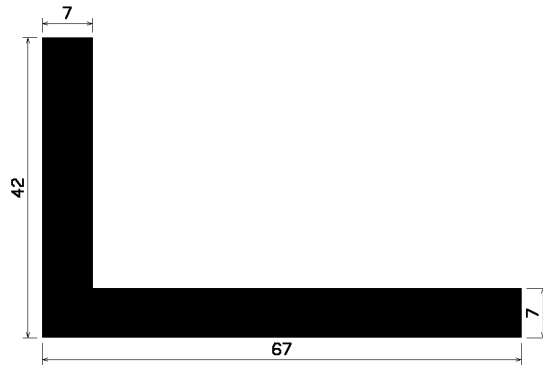

776  
EP/s/ 2444

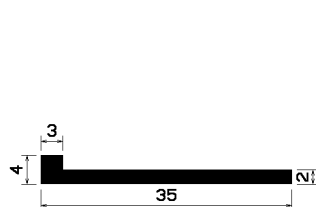

823  
EP/s/ 2672

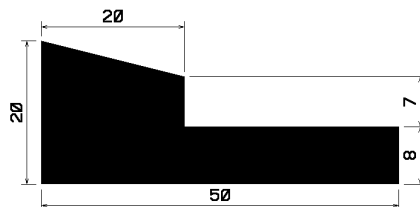

908  
EP/s/3088

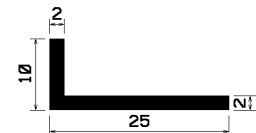

911  
EP/s/ 3092

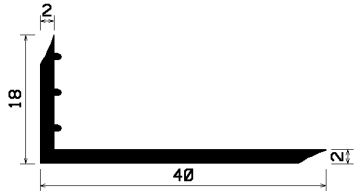

1072  
Si/g/ 3497

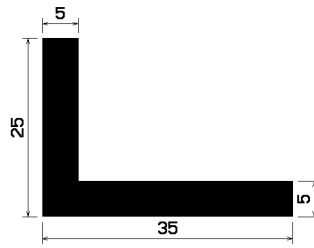

1186  
EP/s/ 1743

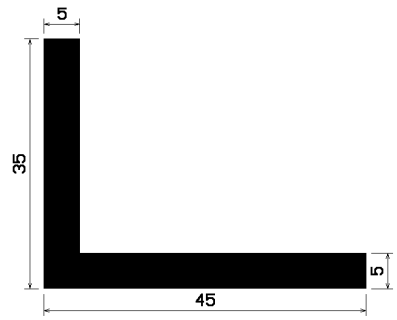

1197  
EP/s/ 1742

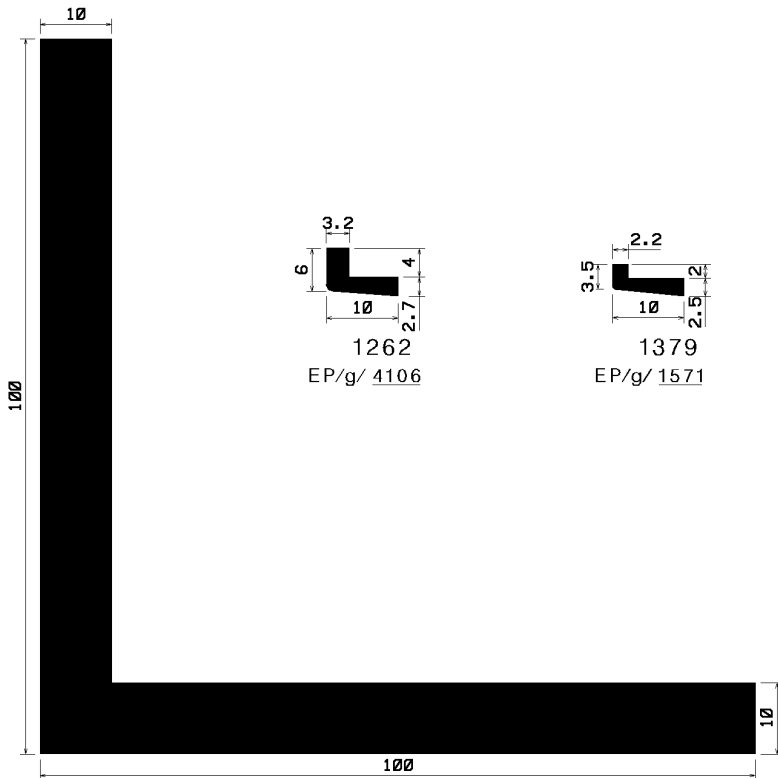

1509  
EP/s/ 4696

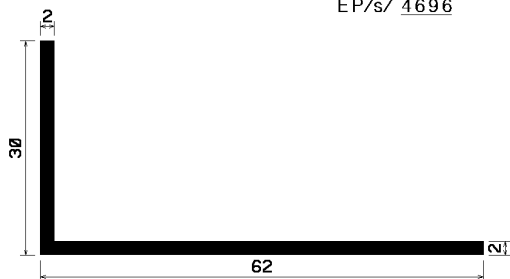

1691  
EP/s/ 5762

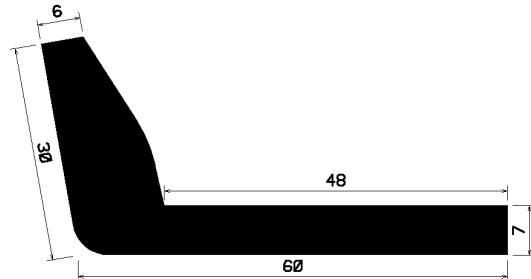

1747  
EP/s/ 5988

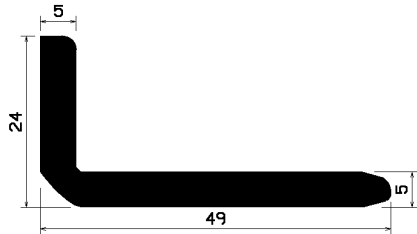

1791  
Si/I/ 6088

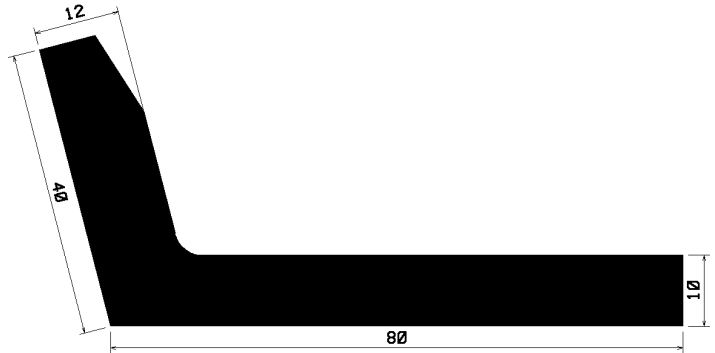

1798  
EP/s/ 6108

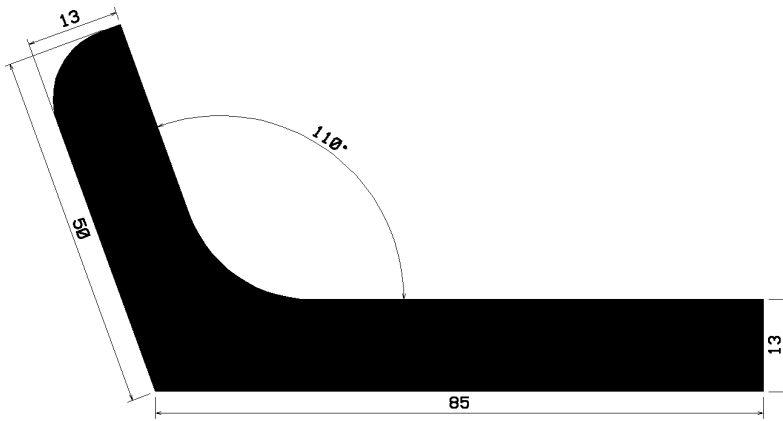

1855  
EP/s/ 6448

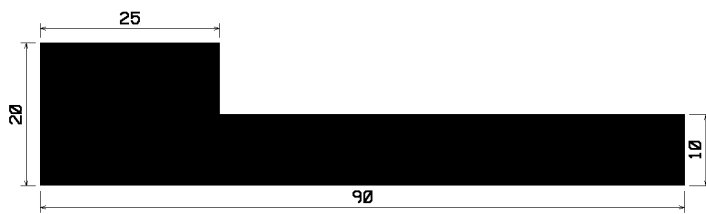

1863  
EP/s/ 6544

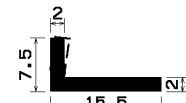

1895  
Si/I/ 6590

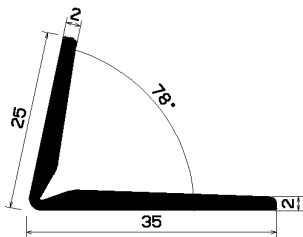

1901  
Si/s/ 6622

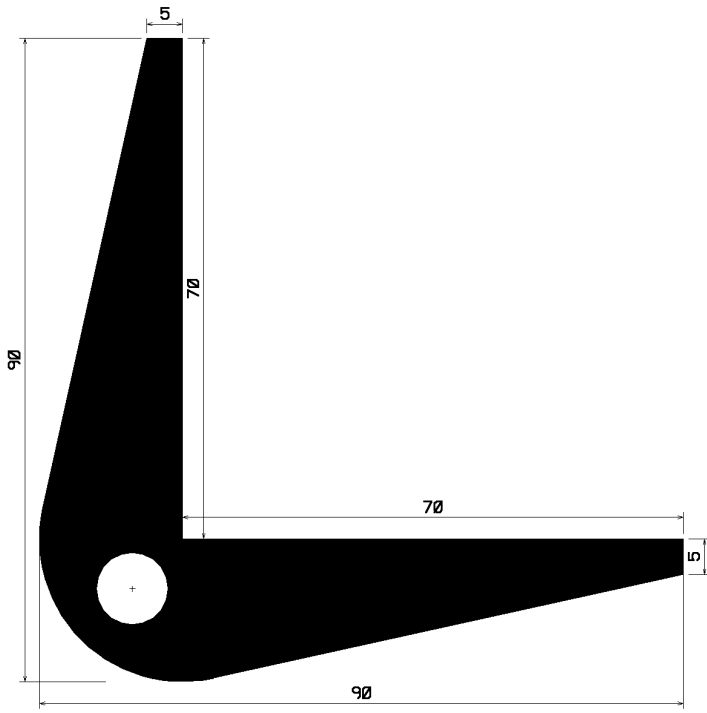

1963  
EP/s/ 6871

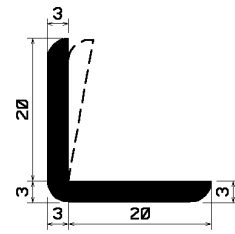

1994  
EP/s/ 6975

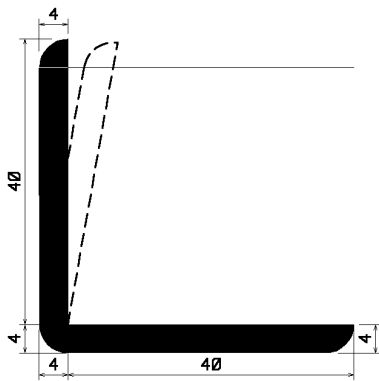

1996  
EP/s/ 6974

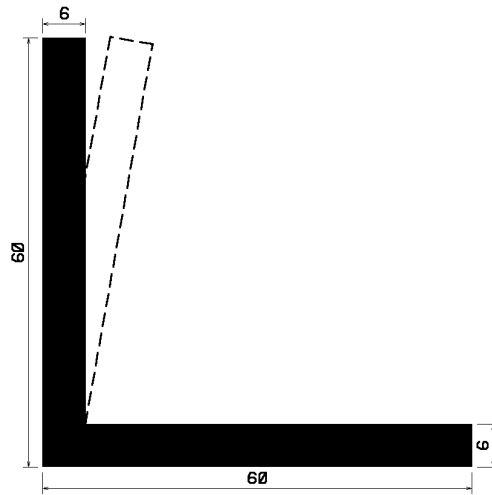

2059  
EP/s/ 7158

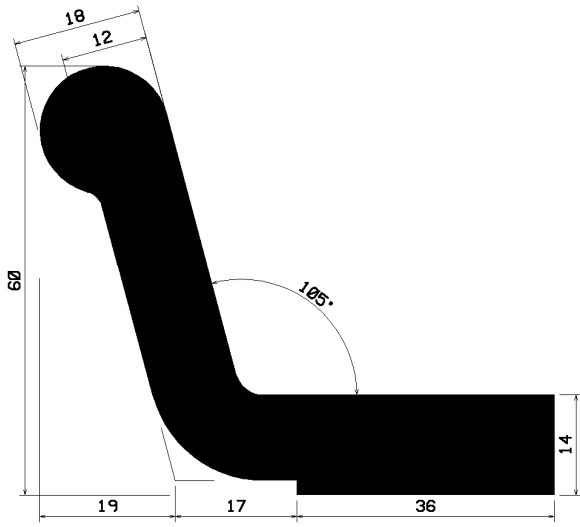

2067

NR/SBR/s/ 7168

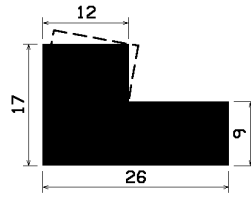

2170

EP/s/ 7620

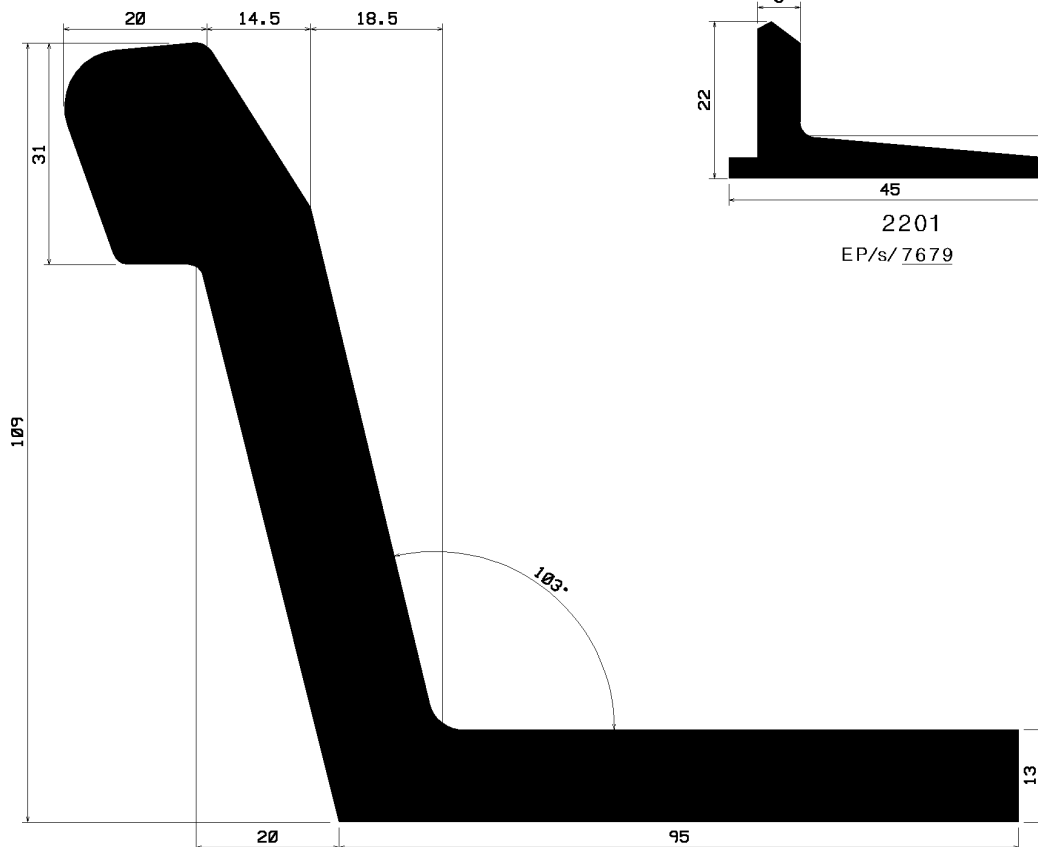

2267

EP/s/ 7941

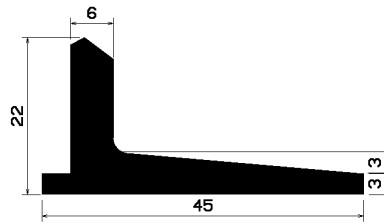

2201

EP/s/ 7679

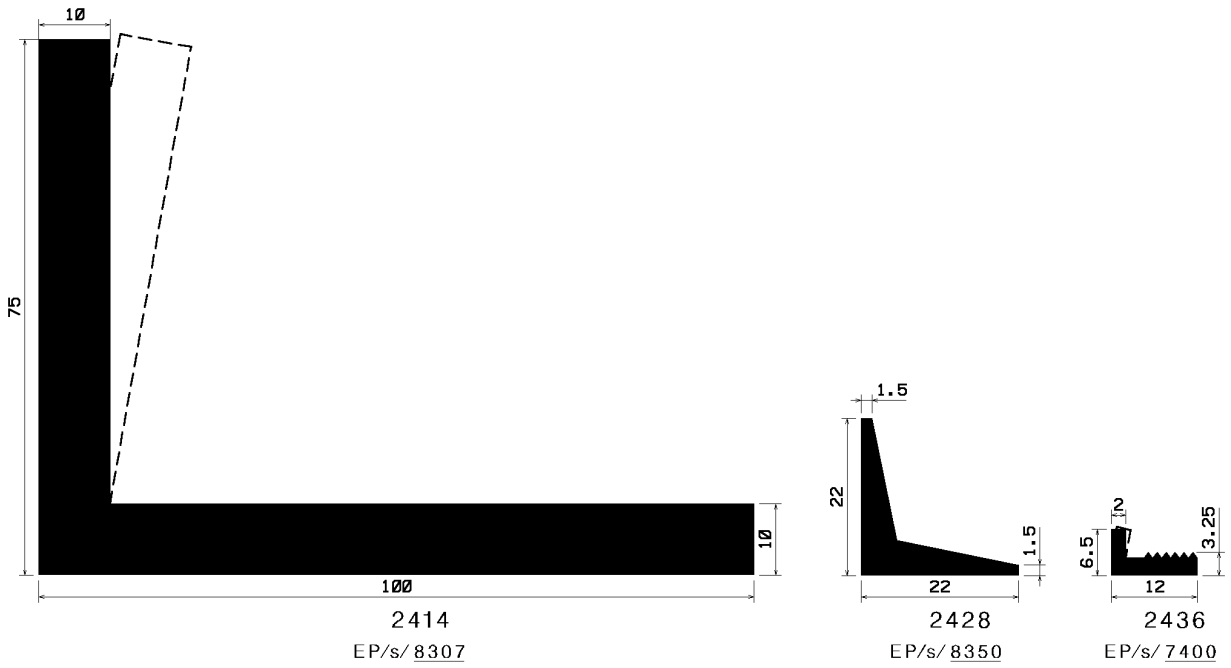
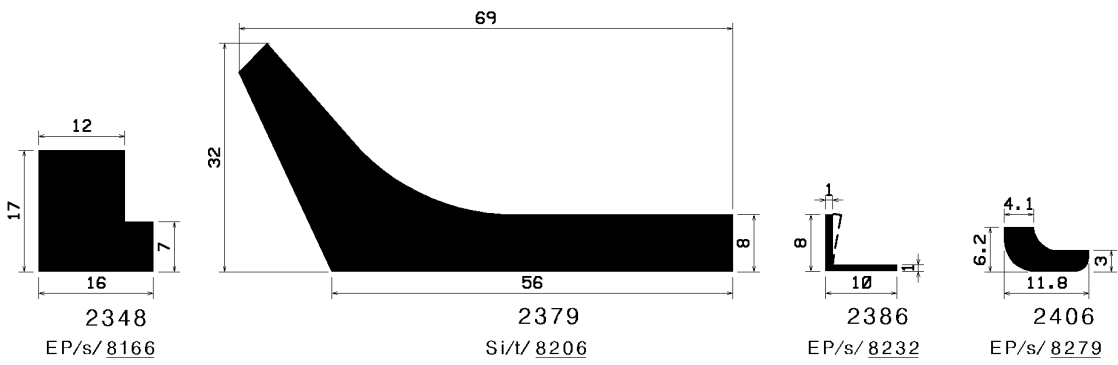
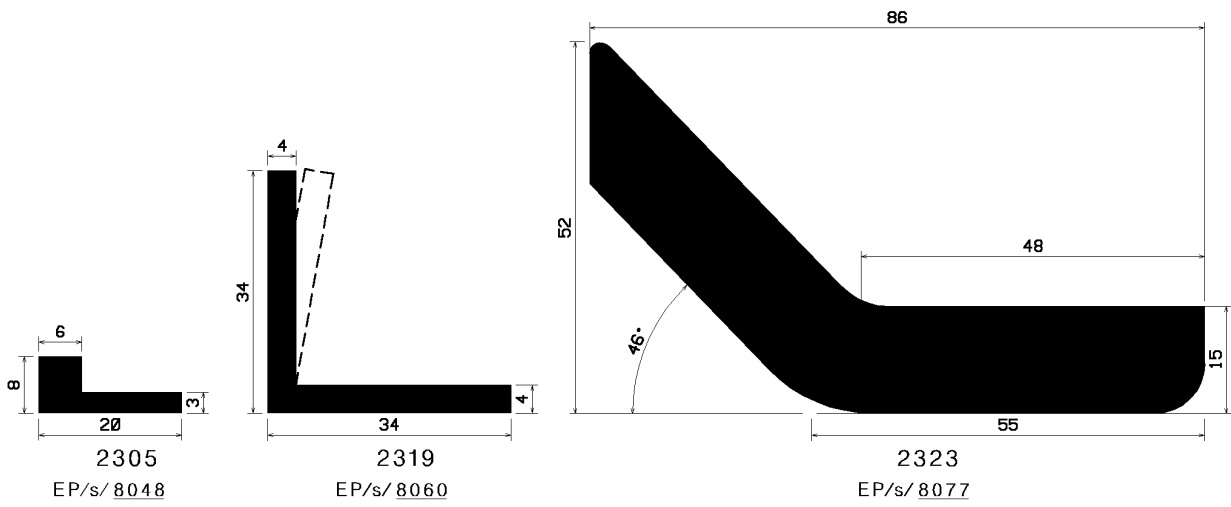

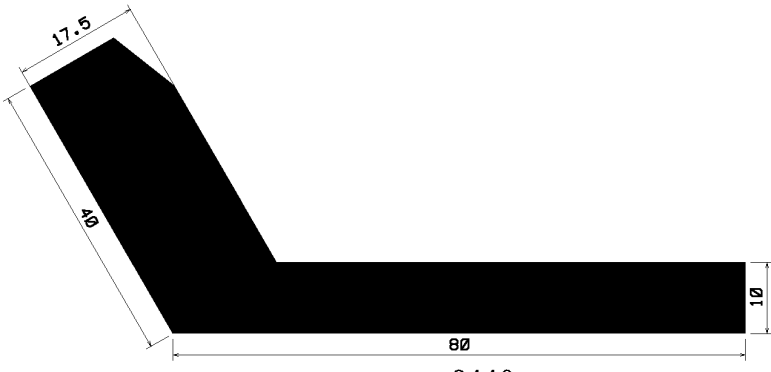

2440  
EP/s/7406

# Sponge rubber

## Legend

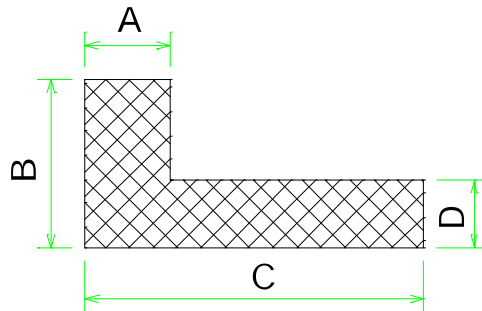

25999

means

Profile-No.

EP / s / 9999 / (9998)

means

Quality / Colour / Article-No. / (Article-No. with sa)

sa = self adhesive

### Quality

CR	Neoprene
EP	EPDM
NBR	Perbunan
NK	Natural rubber
Si	Silicone
SPS	Foam silicone
FPM	VITON®
PVC	Soft-PVC
EVA	Ethylenvinylacetat
SBR	Buna (Styrol-Butadien)
-FR	fire resistant

### Colours

s	black
g	grey
w	white
az	anthracite
bg	beige
br	brown
hg	light-grey
rb	red-brown
t	translucent
r	red
x	colour selectable

® = Entered registered trade mark of the company DuPont

# Sponge rubber

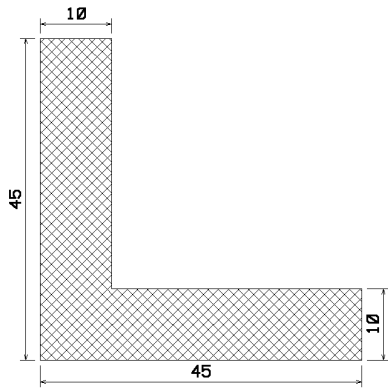

25018  
EP/s/ 0278

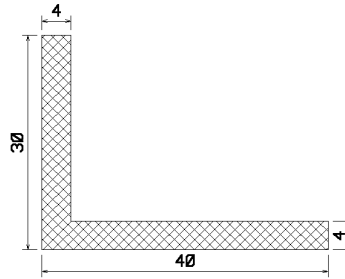

25041  
EP/s/ 0300

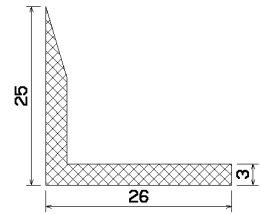

25064  
EP/s/ 0320

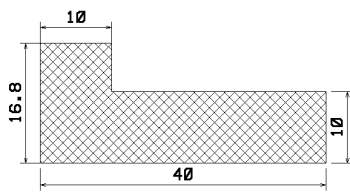

25148  
EP/s/ 0401

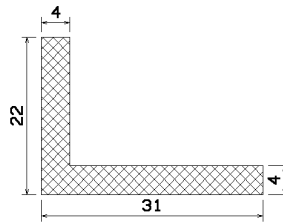

25151  
EP/s/ 0404

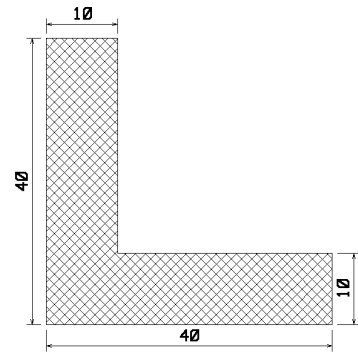

25163  
EP/s/ 1260/(4394)

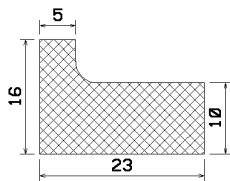

25193  
EP/s/ 2067

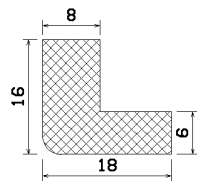

25244  
EP/s/ 2998

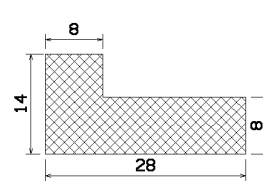

25259  
EP/s/ 3068

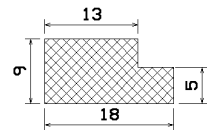

25276  
CR/g/ 3255  
CR/rb/ 4136

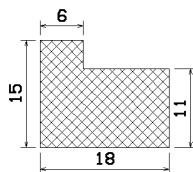

25321  
CR/s/ 3589

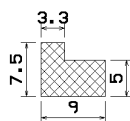

25331  
EP/g/ 3650

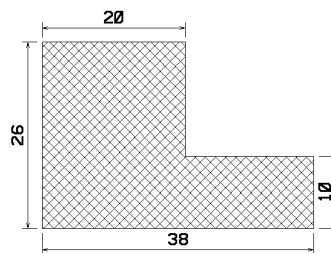

25332  
EP/s/ 3656

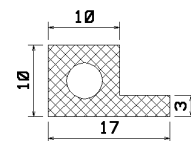

25363  
CR-FR/s/ 3872

# Sponge rubber

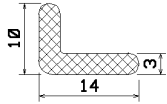

25586

CR/s/ 5091

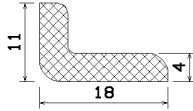

25587

CR/s/ 5092

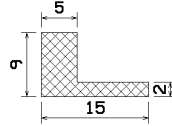

25637

EP/s/ 4588

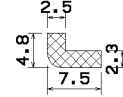

25652

EP/g/ 4742

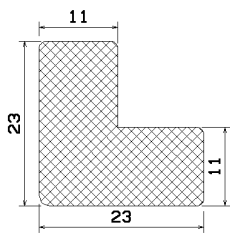

25783

EP/s/ 7555

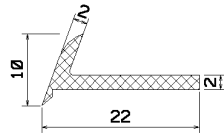

25802

EP/s/ 8253