

RHIMEX

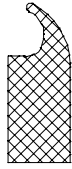

**Profiles of rubber, sponge rubber,
silicone, foam silicone**

Renovation door sealings

DS



RHIMEX

We provide custom made profiles for you

Request Order Sample request

Print and fill out this form

Make a stamp of the desired profile (if you have one)

Send it to info@rhimex.com

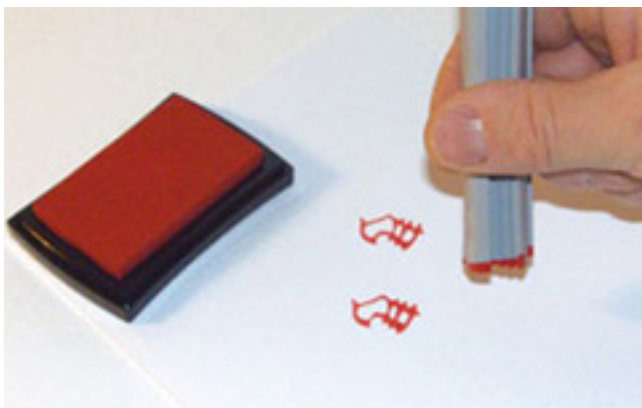

Date
Name
Address
Article number (if you have one)
Color
Quantity (meters)
Remarks

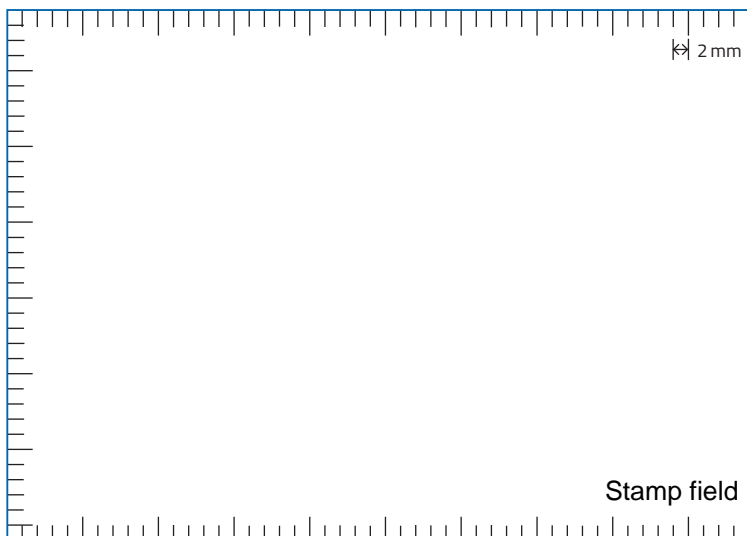

specialist
in **rubberprofiles**
and more...

 **RHIMEX**

Wir haben die passende Dichtung für Sie.

Anfrage
 Bestellung
 Musteranforderung

Und so geht's:

Formular ausdrucken und ausfüllen

Stempelabdruck anfertigen

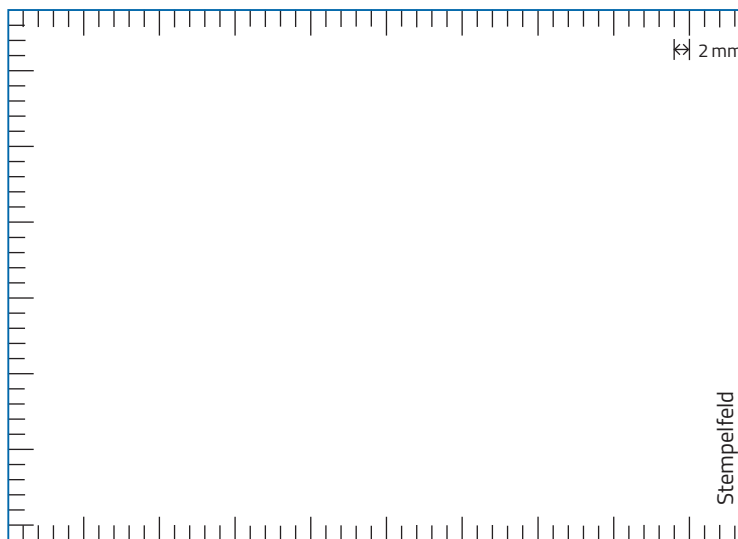
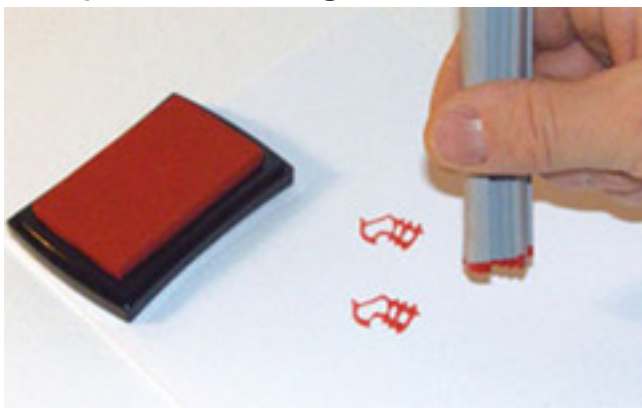

Datum:	
Kundennr.:	(falls vorhanden)
Adresse oder Firmenstempel:	
Bitte angeben: Name/Firma, Branche, Straße, PLZ, Ort, Telefon/Fax, E-Mail	
Artikelnr.:	(falls vorhanden)
Farbe:	
Metermenge:	
Bemerkungen:	



specialist
in **rubberprofiles**
and more...

Wij hebben het juiste profiel voor u!

Aanvraag Bestelling Monsteraanvraag

Print dit formulier en vul de gegevens in

Maak een stempel van het profiel in het stempelveld hieronder (als u dit heeft)

Stuur uw aanvraag naar info@rhimex.com

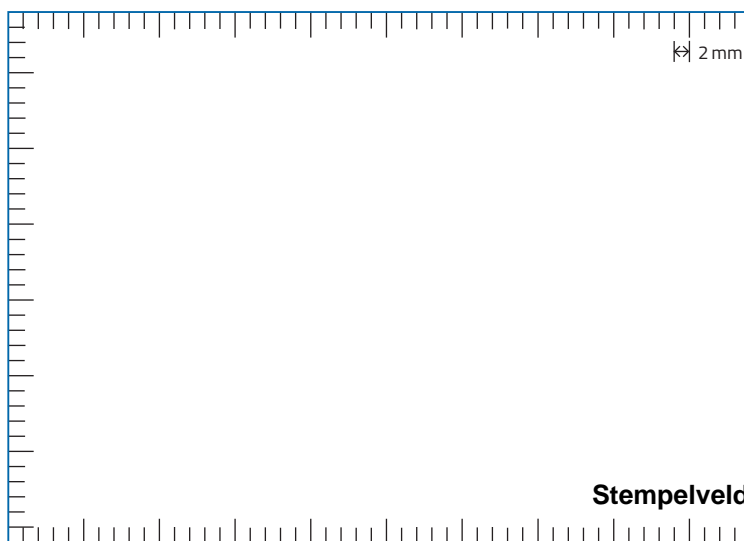
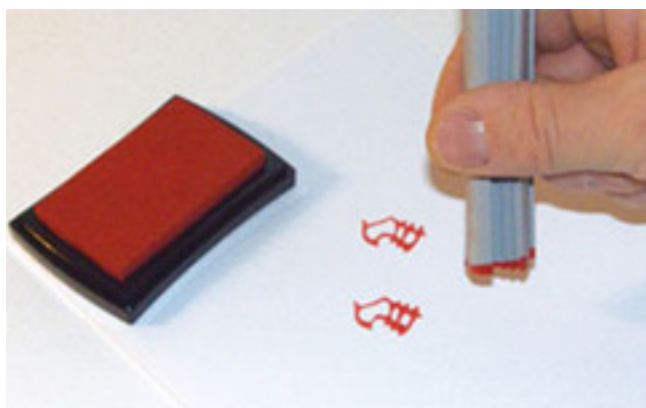

Datum
Naam
Adresgegevens
Artikelnummer
Kleur
Hoeveelheid (meters)
Opmerkingen



specialist
in **rubberprofiles**
and more...

Dichtungen die so oder ähnlich aussehen
finden Sie auf:

Seite 1 bis 6

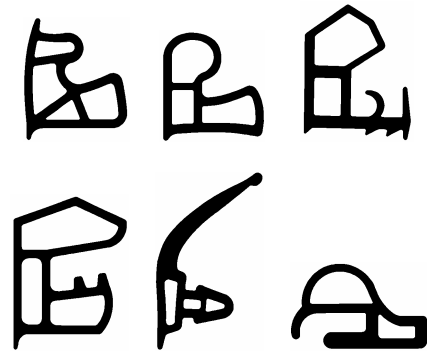

Dichtungen die so oder ähnlich aussehen
finden Sie auf:

Seite 10 bis 12

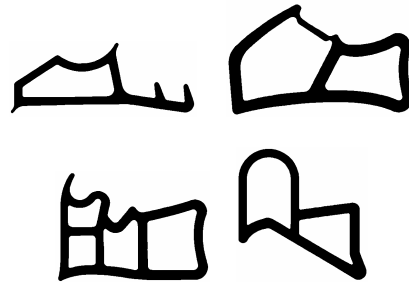

Dichtungen die so oder ähnlich aussehen
finden Sie auf:

Seite 15 bis 16

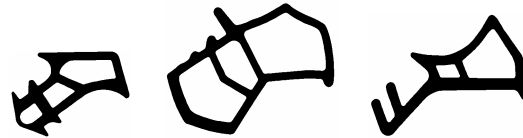

Dichtungen die so oder ähnlich aussehen
finden Sie auf:

Seite 20



Dichtungen die so oder ähnlich aussehen
finden Sie auf:

Seite 22

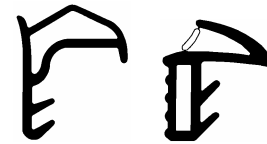

Dichtungen die so oder ähnlich aussehen
finden Sie auf:

Seite 25 bis 33

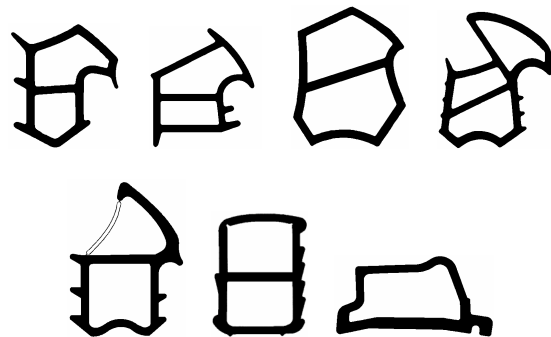

Dichtungen die so oder ähnlich aussehen
finden Sie auf:

Seite 40

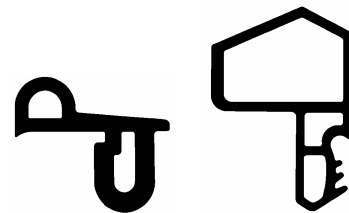

Dichtungen die so oder ähnlich aussehen
finden Sie auf:

Seite 45 bis 46

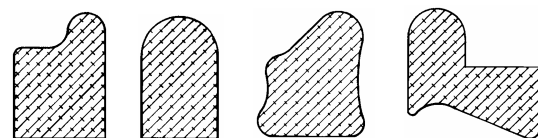

Dichtungen die so oder ähnlich aussehen
finden Sie auf:

Seite 50 bis 52

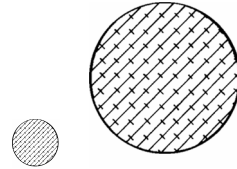

Dichtungen die so oder ähnlich aussehen
finden Sie auf:

Seite 55 bis 64

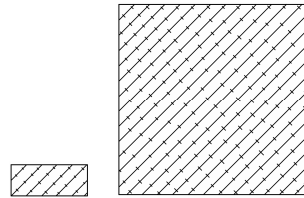

Dichtungen die so oder ähnlich aussehen
finden Sie auf:

Seite 70 bis 77

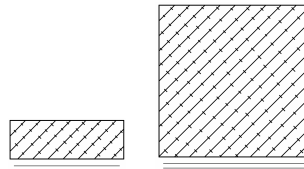

Dichtungen die so oder ähnlich aussehen
finden Sie auf:

Seite 80 bis 83

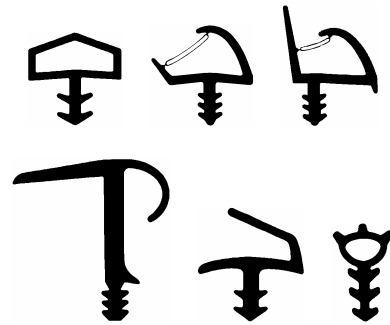

Dichtungen die so oder ähnlich aussehen
finden Sie auf:

Seite 90 bis 94



Dichtungen die so oder ähnlich aussehen
finden Sie auf:

Seite 100



Dichtungen die so oder ähnlich aussehen
finden Sie auf:

Seite 105 bis 107

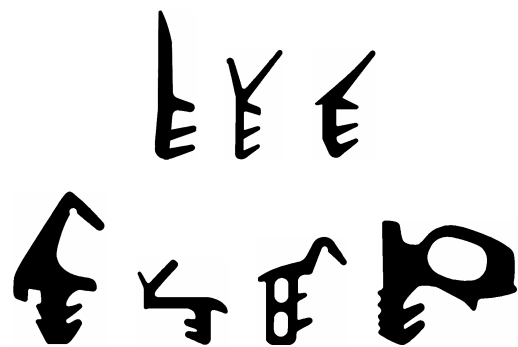

Dichtungen die so oder ähnlich aussehen
finden Sie auf:

Seite 110 bis 112

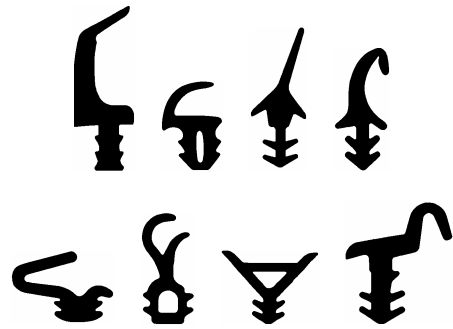

Dichtungen die so oder ähnlich aussehen
finden Sie auf:

Seite 115 bis 116

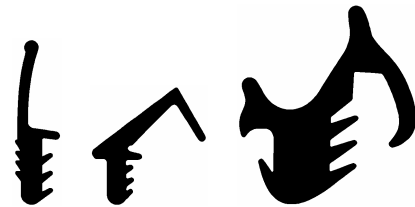

Dichtungen die so oder ähnlich aussehen
finden Sie auf:

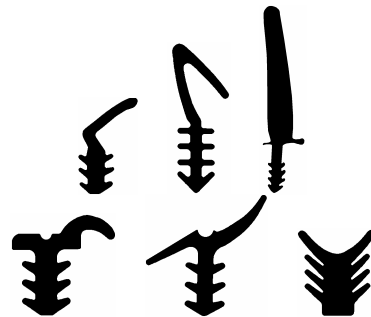

Seite 120 bis 121

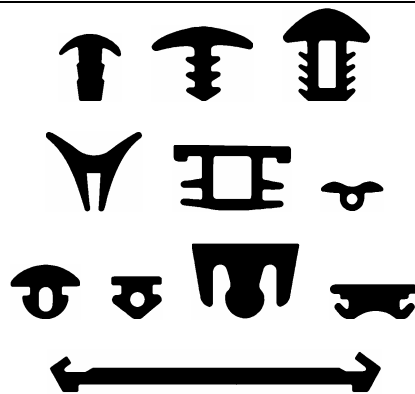

Dichtungen die so oder ähnlich aussehen
finden Sie auf:

Seite 125 bis 130

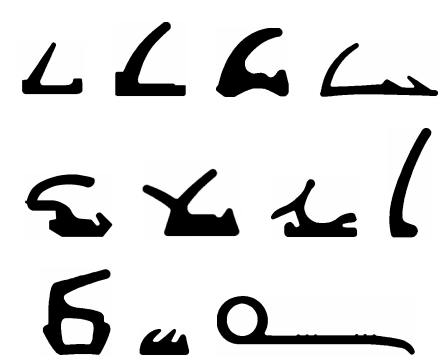

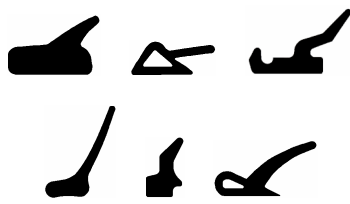
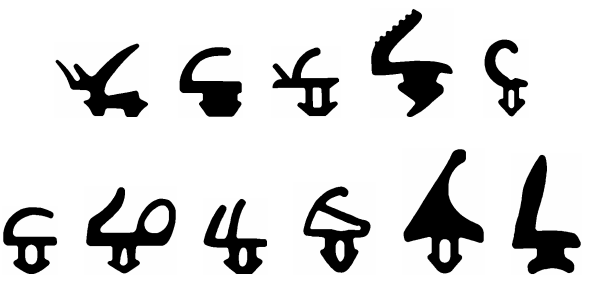
<p>Dichtungen die so oder ähnlich aussehen finden Sie auf:</p> <p>Seite 135 bis 141</p>	 <p>Handwritten symbols in three rows: Row 1: four symbols resembling 'L', 'L', 'L', 'L' with variations; Row 2: four symbols resembling 'E', 'X', 'L', 'L'; Row 3: three symbols resembling 'B', 'u', and a long horizontal line.</p>
<p>Dichtungen die so oder ähnlich aussehen finden Sie auf:</p> <p>Seite 145 bis 150</p>	 <p>Handwritten symbols in three rows: Row 1: four symbols resembling '1', '4', '1', '1'; Row 2: five symbols resembling 'e', 'L', 'L', 'X', 'X'; Row 3: three symbols resembling '1', 'L', '1'.</p>
<p>Dichtungen die so oder ähnlich aussehen finden Sie auf:</p> <p>Seite 155 bis 156</p>	 <p>Handwritten symbols in two rows: Row 1: three symbols resembling 'L', 'L', 'L'; Row 2: three symbols resembling 'L', 'L', 'L'.</p>
<p>Dichtungen die so oder ähnlich aussehen finden Sie auf:</p> <p>Seite 160 bis 167</p>	 <p>Handwritten symbols in two rows: Row 1: five symbols resembling 'X', 'L', 'L', 'L', 'L'; Row 2: six symbols resembling 'L', 'L', 'L', 'L', 'L', 'L'.</p>

Dichtungen die so oder ähnlich aussehen
finden Sie auf:

Seite 170 bis 172

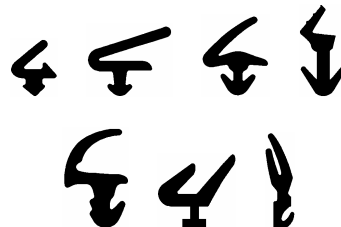

Dichtungen die so oder ähnlich aussehen
finden Sie auf:

Seite 175 bis 179

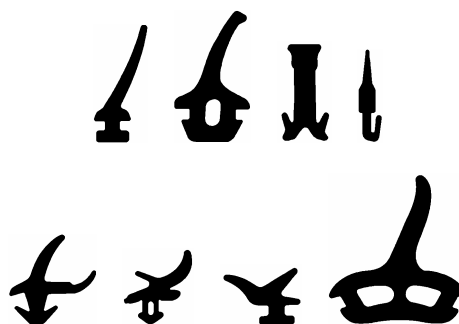

Dichtungen die so oder ähnlich aussehen
finden Sie auf:

Seite 185 bis 187

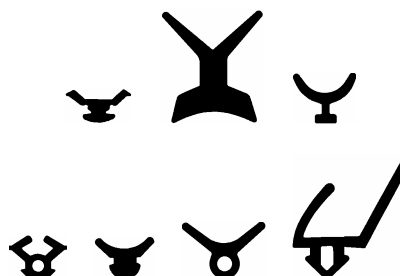

Dichtungen die so oder ähnlich aussehen
finden Sie auf:

Seite 190 bis 192

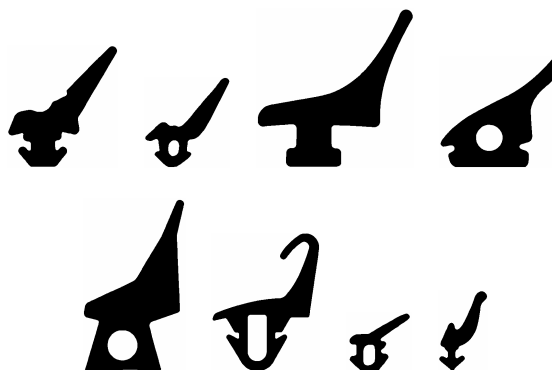

Dichtungen die so oder ähnlich aussehen
finden Sie auf:

Seite 195 bis 198

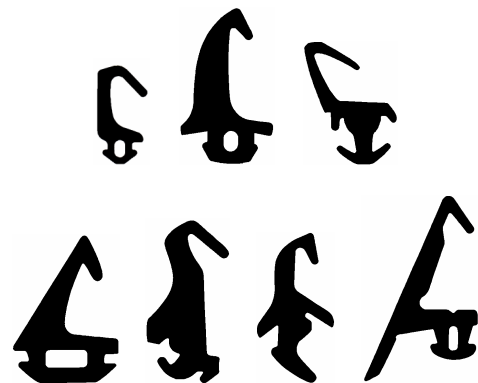

Dichtungen die so oder ähnlich aussehen
finden Sie auf:

Seite 205 bis 206

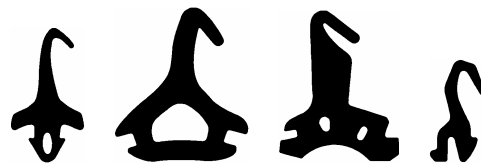

Dichtungen die so oder ähnlich aussehen
finden Sie auf:



Seite 210 bis 211

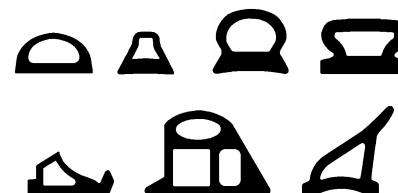

Dichtungen die so oder ähnlich aussehen
finden Sie auf:

Seite 215 bis 219

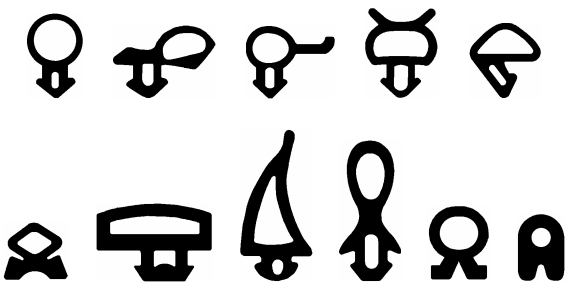
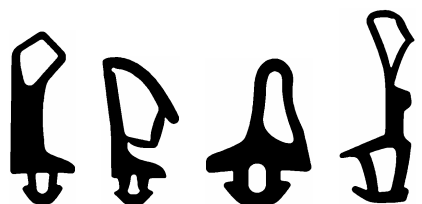
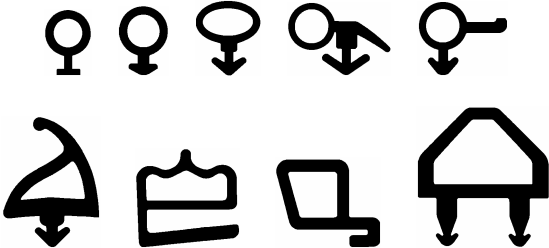

<p>Dichtungen die so oder ähnlich aussehen finden Sie auf:</p> <p>Seite 225 bis 232</p>	
<p>Dichtungen die so oder ähnlich aussehen finden Sie auf:</p> <p>Seite 235</p>	
<p>Dichtungen die so oder ähnlich aussehen finden Sie auf:</p> <p>Seite 240 bis 242</p>	
<p>Dichtungen die so oder ähnlich aussehen finden Sie auf:</p> <p>Seite 245 bis 248</p>	

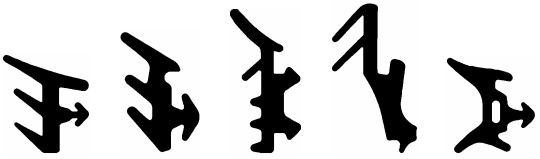
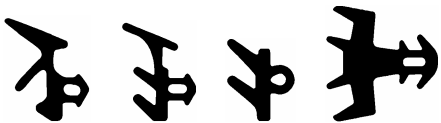
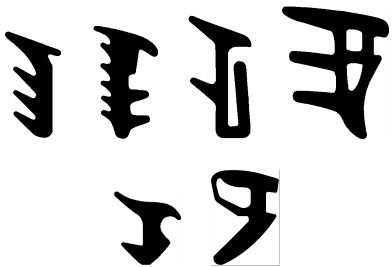
<p>Dichtungen die so oder ähnlich aussehen finden Sie auf:</p> <p>Seite 255 bis 256</p>	
<p>Dichtungen die so oder ähnlich aussehen finden Sie auf:</p> <p>Seite 260 bis 261</p>	
<p>Dichtungen die so oder ähnlich aussehen finden Sie auf:</p> <p>Seite 265 bis 266</p>	
<p>Dichtungen die so oder ähnlich aussehen finden Sie auf:</p> <p>Seite 270 bis 273</p>	

Dichtungen die so oder ähnlich aussehen
finden Sie auf:

Seite 275 bis 276

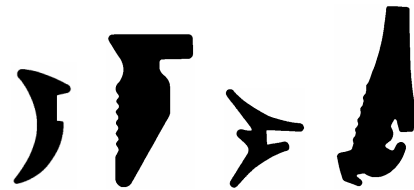

Dichtungen die so oder ähnlich aussehen
finden Sie auf:

Seite 280 bis 281

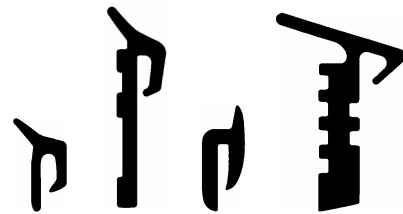

Dichtungen die so oder ähnlich aussehen
finden Sie auf:



Seite 285 bis 287



Dichtungen die so oder ähnlich aussehen
finden Sie auf:

Seite 290 bis 294

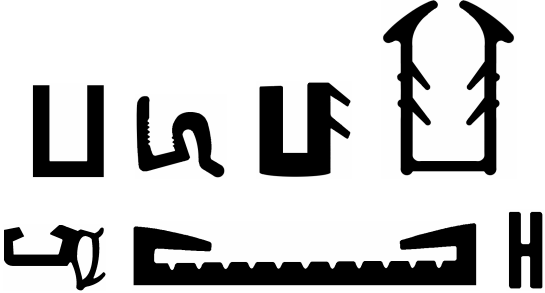

<p>Dichtungen die so oder ähnlich aussehen finden Sie auf:</p> <p>Seite 300</p>	
<p>Dichtungen die so oder ähnlich aussehen finden Sie auf:</p> <p>Seite 305 bis 308</p>	
<p>Dichtungen die so oder ähnlich aussehen finden Sie auf:</p> <p>Seite 315</p>	
<p>Dichtungen die so oder ähnlich aussehen finden Sie auf:</p> <p>Seite 320</p>	

Dichtungen die so oder ähnlich aussehen
finden Sie auf:

Seite 325

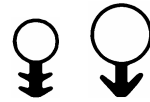

Preise für die Artikel
Z und M
finden Sie auf:







Seite 400 bis 425





Preise für die Artikel
F, FSW, RF, RT, R, SIA und SIT
finden Sie auf:





Seite 450 bis 537





Allgemeine Verkaufs- und Lieferbedingungen
finden Sie auf:

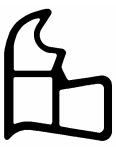





der nächsten Seite

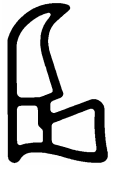



Z 557 be/gr/w	Z 513 gr	Z 618 gr	Z 634 gr	Z 657 gr/w	Z 908 gr
					







Z 529-B gr/w	Z 635 gr	Z 1073		Z 7516	Z 557-A gr/w
					

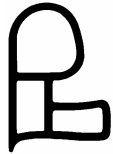



Z 535 gr/w	Z 541 gr	Z 525 gr/w		Z 636 be	Z 1014
					





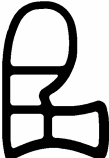

Z 569 gr/w	Z 591 gr/w	Z 589 gr/w	Z 511 gr/w		Z 953 gr
					





Z 940 gr	Z 944 gr	Z 947 gr	Z 984 gr	Z 943 gr	Z 931 gr
					





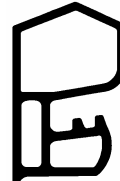

Z 594 gr/w	Z 554 gr/w	Z 599 gr	Z 620 gr	Z 621 gr	Z 622 gr
					







Z 559 gr	Z 595 gr/w	Z 1009 gr	Z 935 gr	Z 640 gr	Z 619 gr
					



Z 617 gr	Z 585 gr	Z 934		Z 1011	Z 983
					



Z 638 gr	Z 649 gr	Z 505 gr/w	Z 687 gr	Z 600 gr	Z 637 gr
					

Z 518 gr/w	Z 538 gr	Z 596 gr	Z 596-A	Z 566 gr/w	Z 540 gr
					





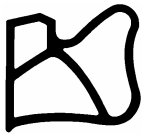

Z 561 gr	Z 582 gr	Z 572 gr	Z 644 gr	Z 933 gr	Z 660 gr
					





Z 1057	Z 955	Z 1035 gr	Z 670	Z 1032	Z 1036 sw
					



Z 568 gr/w	Z 1065				Z 1063
					





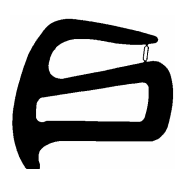

Z 575	Z 641 gr		Z 642		
					

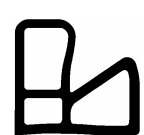
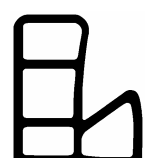



					Z 956
					



Z 613 gr/w	Z 543 gr	Z 1004	Z 662 gr	Z 524 gr	Z 516 gr
					



Z 632 gr	Z 571 gr	Z 937 gr	Z 612 gr	Z 574 gr	Z 973
					



Z 698 gr	Z 515 gr		Z 939 gr	Z 611 gr	Z 971
					



Z 677 gr	Z 768-H sw	Z 936 gr	Z 579 gr	Z 549 gr	Z 548 gr
					



Z 920	Z 1044	Z 1049	Z 1054	Z 1043	
					



Z 546 gr	Z 651		Z 1068		
					



Z 633 gr	Z 520 gr/w	Z 623
		

Z 688 gr	Z 523 gr	Z 506 gr
		

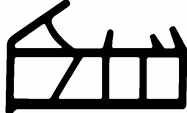

Z 556 gr	Z 958 gr/w	Z 959 gr
		



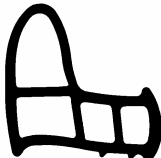
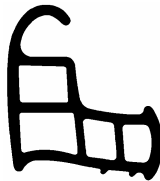

Z 941 gr	Z 1072	Z 7517 gr
		

Z 659 gr	Z 678	Z 946 gr
		



Z 1015		Z 685 gr
		

Z 573 gr	Z 992	Z 997
		

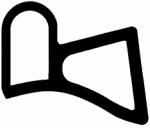

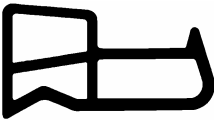

Z 1002	Z 645 gr	Z 693 gr
		



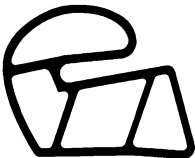

Z 567 gr	Z 536 gr	Z 680 gr	Z 560 gr	Z 558 gr	Z 522 gr
					

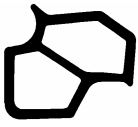

Z 658 gr	Z 1017				
					

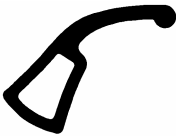

Z 987	Z 681 gr	Z 1027
		



Z 913 gr	Z 993	
		



Z 517 gr	Z 942 gr	Z 606 gr	Z 652 gr	Z 519 gr	Z 968
					

Z 689	Z 1000	Z 1008		Z 1070 gr	
					





Z 639	Z 1047	Z 576 gr
		



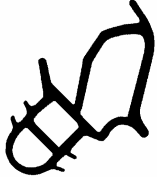



Z 1042 gr	Z 1045	Z 1037 gr
		







Z 1013	Z 1019 sw	Z 1001
		

Z 1020	Z 1025	Z 1026
		





				Z 7503
				



Z 501 gr/w	Z 671 gr	Z 604 gr			Z 961
					



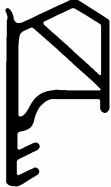

Z 530 gr/w	Z 502 gr	Z 664 gr	Z 661 gr	Z 630 gr	Z 903 gr
					

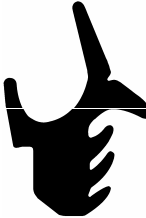

Z 527 gr/w	Z 666 gr/w	Z 533 gr/w	Z 580 gr/w	Z 964 gr/w	Z 508 gr
					







Z 954					Z 950
					





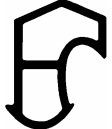

Z 690 gr/w	Z 526 gr/w	Z 694 gr	Z 1007 gr	Z 691 gr	Z 1048
					





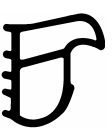

Z 547 gr	Z 564	Z 673 gr		Z 7522 sw	
					







Z 692	Z 537 gr		Z 1040	Z 696	
					







Z 1021 gr	Z 906				Z 945
					







Z 647 gr/w	Z 647-A gr/w	Z 624 gr	Z 565 gr	Z 514 gr/w	Z 901 gr
					







Z 697 gr/w	Z 532 gr/w	Z 592 gr/w	Z 592-A gr/w	Z 514-A gr/w	Z 988
					







Z 926 gr	Z 963 gr	Z 962	Z 528 gr	Z 980 gr	Z 553 gr
					



Z 902 gr	Z 990 gr	Z 625 gr/w	Z 626 gr	Z 504 gr	Z 648 gr
					





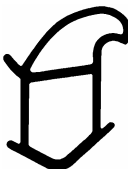
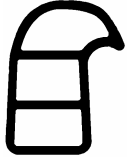

Z 674 gr	Z 974 gr	Z 577 gr/w	Z 1133 gr	Z 1133-B gr	Z 672 gr
					





Z 1033	Z 1038	Z 995	Z 1028	Z 603 gr	Z 1074
					





Z 584 gr	Z 650 gr	Z 923 gr/w	Z 923-B gr/w	Z 905 gr	Z 583 gr
					



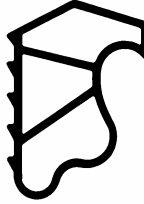
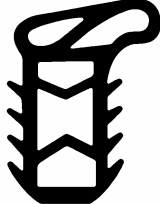

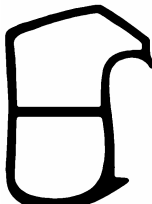
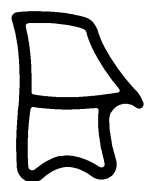

Z 998 gr	Z 991 gr	Z 627 gr	Z 7509	Z 1062	Z 981 gr
					





Z 562 gr	Z 531 gr	Z 578 gr	Z 1022 gr		Z 1118
					







Z 503 gr	Z 521 gr	Z 552 gr	Z 7518 sw	Z 7515 gr	Z 7513 gr
					

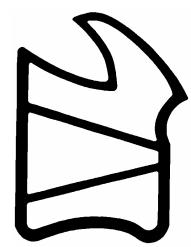



Z 646 gr	Z 930 gr	Z 929 gr	Z 938 gr	Z 684	Z 7501 sw
					







Z 1145 gr	Z 1134 gr	Z 7510	Z 1010 sw	Z 679	Z 907
					







Z 663 gr	Z 668 gr	Z 1003	Z 927 gr	Z 686 gr	Z 1023
					





Z 631 gr	Z 588 gr	Z 7505 gr	Z 7512 gr	Z 1055
				





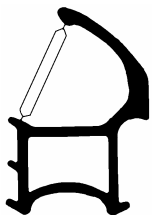

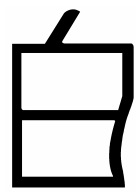
Z 948 gr	Z 602 gr	Z 683 gr	Z 924 gr	Z 667 gr	Z 977 gr
					







Z 949	Z 601 gr		Z 972	Z 967	Z 965
					



Z 655 gr	Z 970	Z 1016	Z 911	Z 982 gr	Z 909 gr
					



Z 976 gr	Z 605 gr	Z 1051	Z 1052	Z 1053	Z 994
					

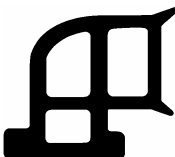
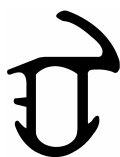

Z 999	Z 7511 sw	Z 676 gr	Z 7502	Z 1061	Z 1059
					







Z 593 gr	Z 550 gr/w	Z 979 gr	Z 916 gr	Z 7508 gr	Z 7504
					





Z 1159	Z 978 sw	Z 614 gr	Z 928 gr	Z 1031	Z 1034
					



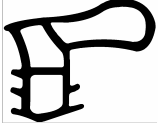

Z 918	Z 608 sw		Z 7514 gr	Z 7521 gr	Z 7519 sw
					

Z 932 gr	Z 615	Z 590 be			
					

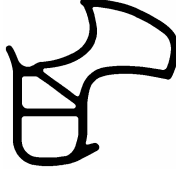



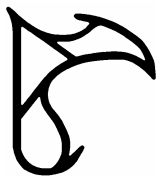

Z 985 gr	Z 915 gr	Z 1012			
					

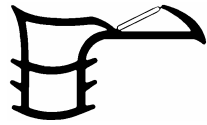
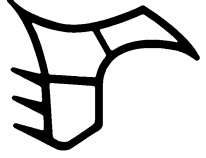
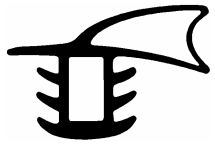



Z 1160 sw	Z 1046 gr	Z 1050 gr	Z 669 gr	Z 665 sw	Z 512 gr
					







Z 507	Z 986 sw	Z 914 gr	Z 914-A gr	Z 1071 gr	Z 975 gr
					

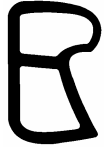



Z 1039	Z 653	Z 969		Z 1041	
					





Z 654	Z 695	Z 1005
		



Z 629 gr	Z 570 gr	Z 598 gr	Z 699 gr	Z 656	Z 682 gr
					





Z 921 gr	Z 628 gr	Z 581 gr	Z 989	Z 7520 sw	Z 904
					





Z 597 gr	Z 510 gr/w	Z 917-A gr	Z 922 gr	Z 925 gr	Z 919 tr
					



Z 996 sw	Z 675 gr	Z 542 gr			Z 960
					

Z 587	Z 1030	Z 610 sw	Z 1029	Z 609 sw	
					



Z 1058	Z 607 gr				
					

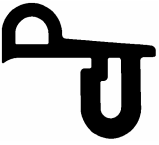

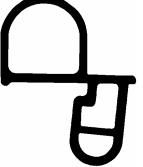
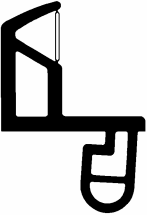

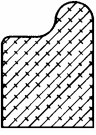

		Z 555 gr	Z 555-A gr	Z 1056 gr	Z 643 gr
					

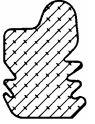
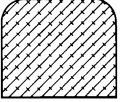
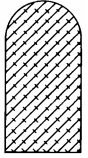
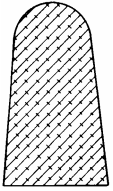

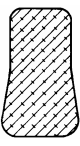
Z 616	Z 1060 gr		Z 545		Z 551
					

Z 544 gr	Z 912 gr	Z 1018 gr	Z 1024	Z 910	
					

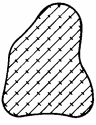
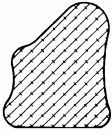

Z 951	Z 952				
					

M 701 gr	M 701-H gr/w	M 713 gr	M 742 gr	M 770 gr/sw	M 708 gr
 Original-Profil aus Moosgummi	 verbesserte Version mit Toleranzausgleich			 20 x 10mm	

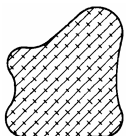
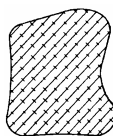
M 710	M 710-B gr	M 728 gr	M 728-H gr/w	M 702 gr	M 702-H gr/w
 ersetzt durch M 710-B	 verbesserte Version	 16 x 10mm Original-Profil aus Moosgummi	 verbesserte Version mit Toleranzausgleich	 17 x 12mm Original-Profil aus Moosgummi	 verbesserte Version mit Toleranzausgleich

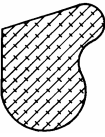
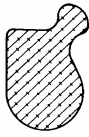
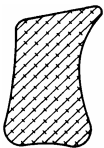
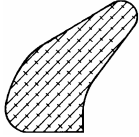
M 730 gr	M 727 gr	M 727-H gr/w	M 706 gr		M 719 gr
	 Original-Profil aus Moosgummi	 verbesserte Version mit Toleranzausgleich			

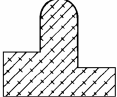
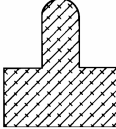
M 704 gr	M 717 gr			M 715 gr	M 705 gr
					



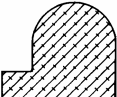
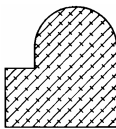
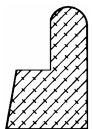

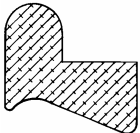
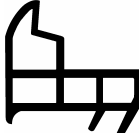
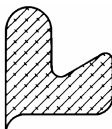
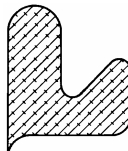

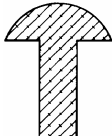
M 703 gr	M 736 gr			M 731	M 731-H gr
				 ersetzt durch M 731-H	 verbesserte Version







M 734 gr	M 711 gr				M 712 gr
					

M 707 gr	M 707-H gr/w		M 724 gr	M 725 gr	
 Original-Profil aus Moosgummi	 verbesserte Version mit Toleranzausgleich				

M 716 gr					
					

M 801 sw	M 802 sw	M 803 sw	M 804 sw	M 753 gr/sw	M 805 sw
 2mm	 2,5mm	 3mm	 3,5mm	 4mm	 4,5mm

M 754 gr/sw	M 747 gr/sw	M 755 gr/sw	M 756 gr/sw	M 806 sw	M 740 gr/sw
 5mm	 6mm	 7mm	 8mm	 9mm	 10mm



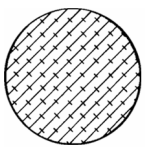
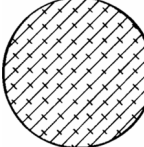
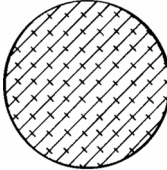
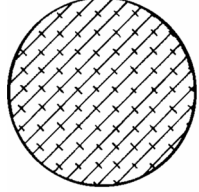

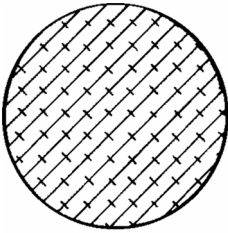
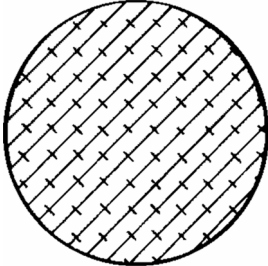
M 807 sw	M 757 gr/sw	M 808 sw	M 714 gr/sw	M 809 sw	M 810 sw
 11mm	 12mm	 13mm	 14mm	 15mm	 16mm

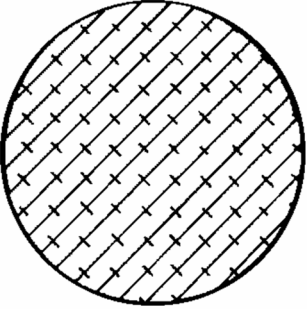
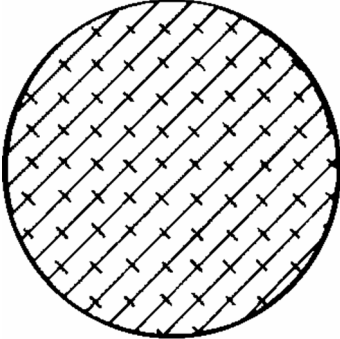

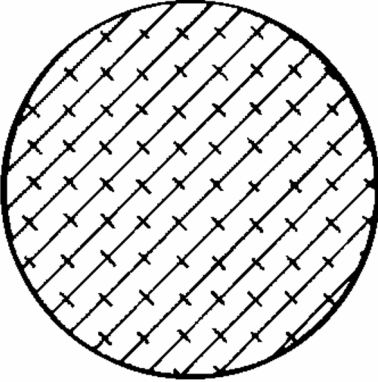
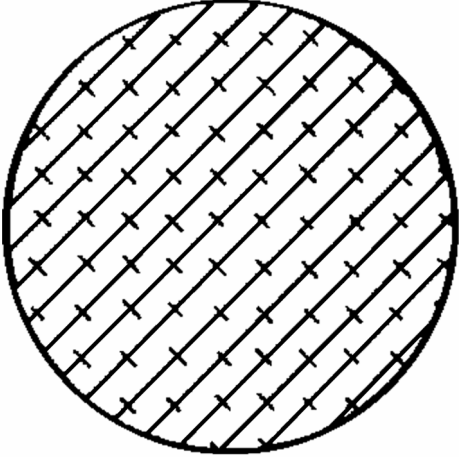
M 811 sw	M 812 sw	M 813 sw	M 814 sw
 18mm	 20mm	 22mm	 25mm

M 815 SW	M 816 SW
 <p data-bbox="456 705 520 734">30mm</p>	 <p data-bbox="1074 725 1137 754">35mm</p>



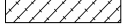

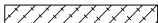
M 817 SW	M 818 SW
 <p data-bbox="456 1263 520 1292">40mm</p>	 <p data-bbox="1074 1276 1137 1305">45mm</p>

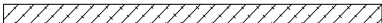
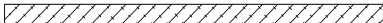

M 819 SW	M 820 SW
 <p data-bbox="456 913 520 943">50mm</p>	 <p data-bbox="1075 954 1139 983">60mm</p>

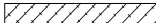

M 821 sw	M 822 sw	M 823 sw	M 824 sw	M 825 sw	M 826 sw
 2 x 10mm	 2 x 15mm	 2 x 20mm	 3 x 10mm	 3 x 12mm	 3 x 15mm

M 827 sw	M 828 sw	M 829 sw	
 3 x 20mm	 3 x 25mm	 3 x 30mm	

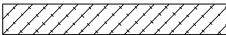
M 830 sw	M 831 sw	
 3 x 40mm	 3 x 50mm	

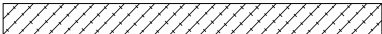

M 744 gr/sw	M 718 gr/sw	M 832 sw	M 709 gr/sw	M 833 sw	
 4 x 8mm	 4 x 10mm	 4 x 12mm	 4 x 15mm	 4 x 20mm	

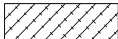
M 834 sw	M 835 sw	M 836 sw
 4 x 25mm	 4 x 30mm	 4 x 40mm

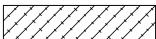
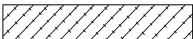
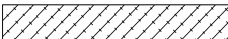

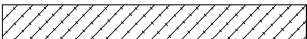
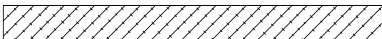
M 837 sw	M 838 sw	M 751 gr/sw	M 700 gr/sw
 4 x 50mm	 5 x 8mm	 5 x 10mm	 5 x 15mm



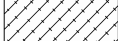

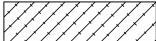
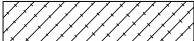
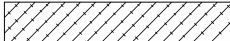

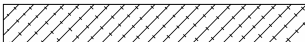
M 839 sw	M 840 sw	M 841 sw	
 5 x 20mm	 5 x 25mm	 5 x 30mm	

M 842 sw	M 843 sw	
 5 x 40mm	 5 x 50mm	

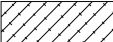

M 844 sw	M 752 gr/sw	M 761 gr/sw	M 775 gr/sw
 5 x 60mm	 6 x 10mm	 6 x 12mm	 6 x 15mm

M 845 sw	M 846 sw	M 847 sw	
 6 x 20mm	 6 x 25mm	 6 x 30mm	

M 848 sw	M 849 sw	
 6 x 40mm	 6 x 50mm	

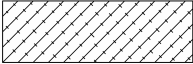
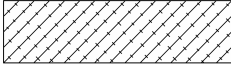
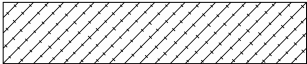
M 850 sw	M 776 gr/sw	M 762 gr/sw	M 777 gr/sw	M 899 gr/sw	M 851 sw
 7 x 10mm	 8 x 8mm	 8 x 10mm	 8 x 12mm	 8 x 15mm	 8 x 20mm

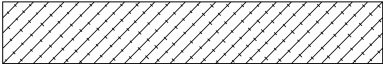
M 773 gr/sw	M 852 sw	M 853 sw
 8 x 25mm	 8 x 30mm	 8 x 40mm

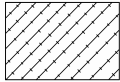
M 854 sw	M 749 gr/sw	M 855 sw	M 748 gr/sw
 8 x 50mm	 10 x 10mm	 10 x 12mm	 10 x 15mm

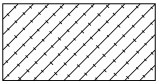
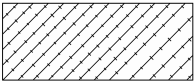
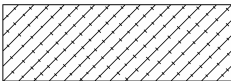
M 774 gr/sw	M 856 sw	M 857 sw	
 10 x 20mm	 10 x 25mm	 10 x 30mm	

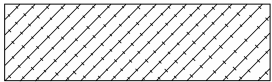
M 858 sw				
 10 x 35mm				

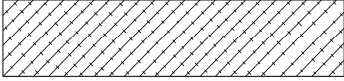
M 859 sw	M 860 sw	
 10 x 40mm	 10 x 45mm	

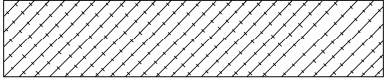
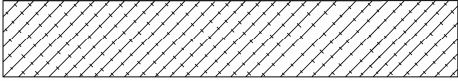
M 861 sw	M 862 sw
 10 x 50mm	 10 x 60mm

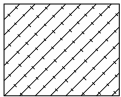
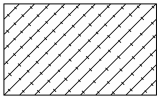
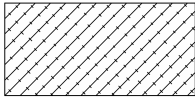
M 760 gr/sw	M 863 sw	M 772 gr/sw	M 864 sw	
 12 x 12mm	 12 x 15mm	 12 x 20mm	 12 x 25mm	

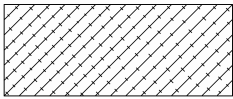
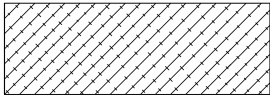
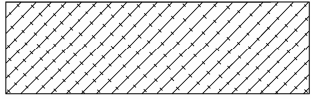
M 865 sw	M 866 sw	M 867 sw
 12 x 30mm	 12 x 35mm	 12 x 40mm

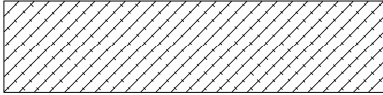
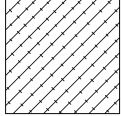
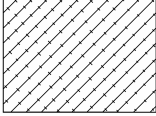
M 868 sw	M 771 gr/sw	M 745 gr/sw	
 12 x 50mm	 15 x 15mm	 15 x 20mm	

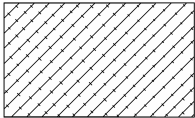
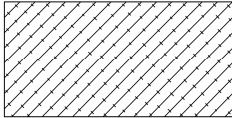
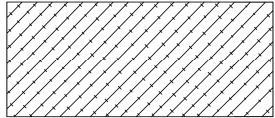
M 869 sw	M 870 sw	M 871 sw
 15 x 25mm	 15 x 30mm	 15 x 35mm

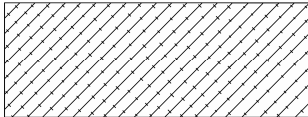
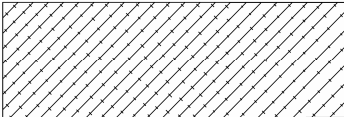
M 872 sw	M 873 sw		
 15 x 40mm	 15 x 45mm		

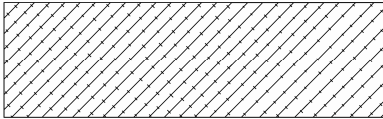
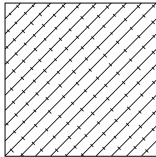
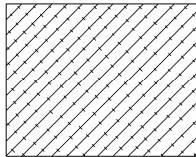
M 874 sw	M 875 sw	M 876 sw
 15 x 50mm	 20 x 20mm	 20 x 25mm

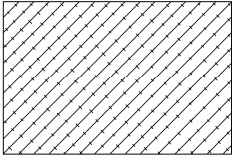
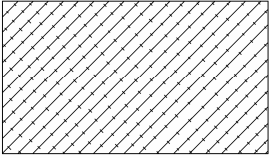
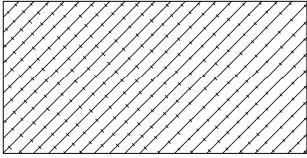
M 877 sw	M 878 sw	M 879 sw
		
20 x 30mm	20 x 35mm	20 x 40mm

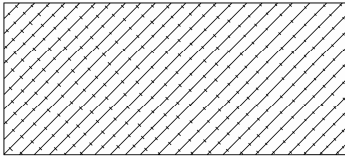
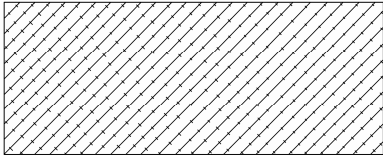
M 880 sw	M 881 sw	
		
20 x 45mm	20 x 50mm	

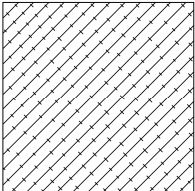
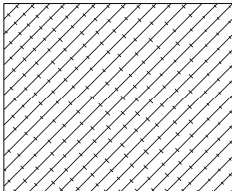
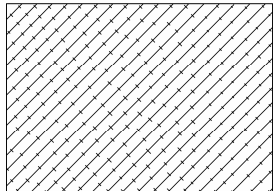
M 882 sw	M 883 sw	M 884 sw
		
25 x 25mm	25 x 30mm	25 x 35mm

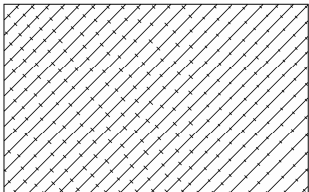
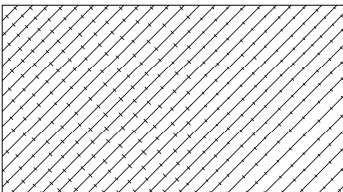
M 885 sw	M 886 sw		
			
25 x 40mm	25 x 45mm		

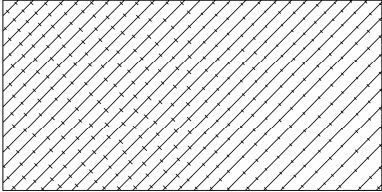
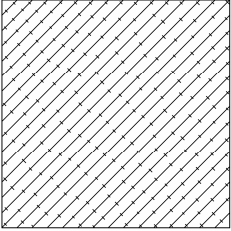
M 887 sw	M 888 sw
 25 x 50mm	 30 x 30mm

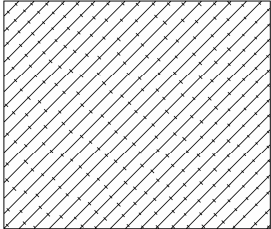
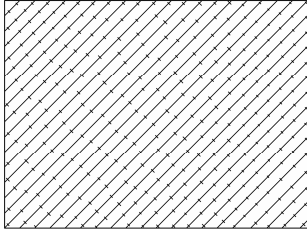
M 889 sw	M 890 sw
 30 x 35mm	 30 x 40mm

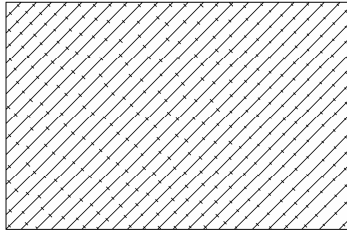
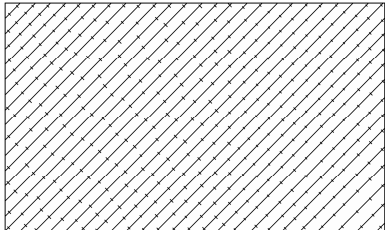

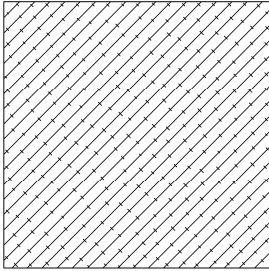
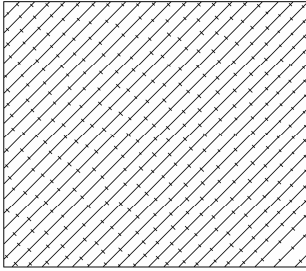

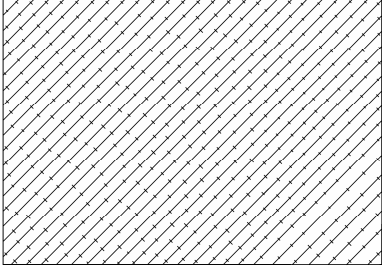
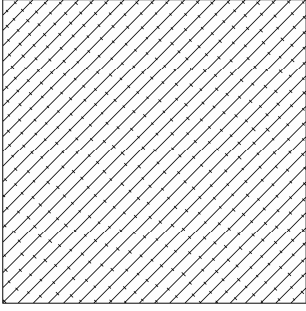
M 891 sw	M 892 sw
 30 x 45mm	 30 x 50mm

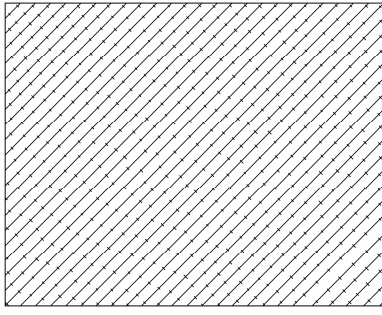

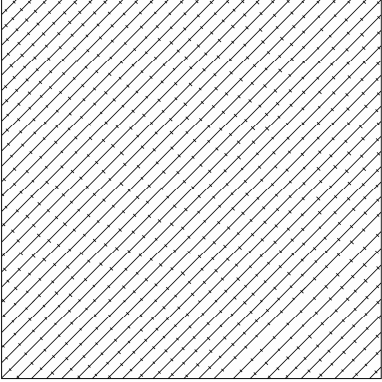
M 893 SW	M 894 SW
 35 x 35mm	 35 x 40mm

M 895 SW	M 896 SW
 35 x 50mm	 40 x 40mm

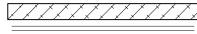

M 897 SW	
 40 x 50mm	

M 898 SW	
 <p data-bbox="432 909 544 936">50 x 50mm</p>	

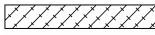
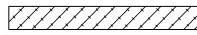
M 821-SK sw	M 822-SK sw	M 823-SK sw	M 1201-SK gr/sw	M 824-SK sw
 2 x 10mm	 2 x 15mm	 2 x 20mm	 2 x 25mm	 3 x 10mm

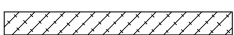
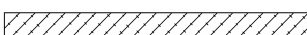
M 825-SK sw	M 826-SK sw	M 827-SK sw	M 828-SK sw	
 3 x 12mm	 3 x 15mm	 3 x 20mm	 3 x 25mm	

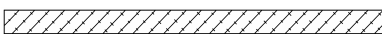

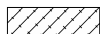
M 829-SK sw	M 830-SK gr/sw		
 3 x 30mm	 3 x 40mm		

M 831-SK gr/sw	M 744-SK gr/sw	M 718-SK sw	M 832-SK sw
 3 x 50mm	 4 x 8	 4 x 10mm	 4 x 12mm

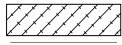
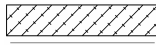
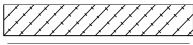
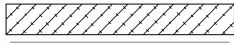
Profile als Montagehilfe einseitig selbstklebend auf der Breitseite ausgerüstet

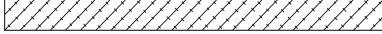
M 709-SK sw	M 833-SK sw	M 834-SK sw	M 835-SK sw
 4 x 15mm	 4 x 20mm	 4 x 25mm	 4 x 30mm

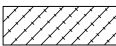
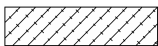

M 836-SK gr/sw	M 837-SK gr/sw
 4 x 40mm	 4 x 50mm

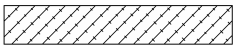
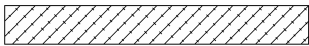
	M 751-SK sw	M 700-SK sw	M 839-SK sw	M 840-SK sw
	 5 x 10mm	 5 x 15mm	 5 x 20mm	 5 x 25mm

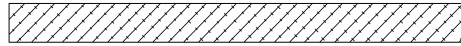

M 841-SK sw	M 842-SK sw
 5 x 30mm	 5 x 40mm

Profile als Montagehilfe einseitig selbstklebend auf der Breitseite ausgerüstet

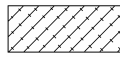
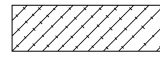
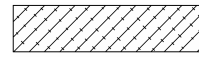

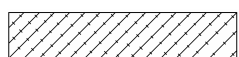
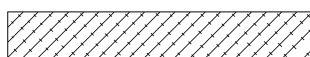
M 843-SK sw	M 844-SK sw
 5 x 50mm	 5 x 60mm

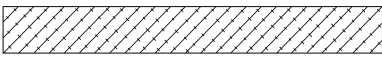
M 752-SK sw	M 761-SK gr/sw	M 775-SK sw	M 845-SK sw	M 846-SK sw
 6 x 10mm	 6 x 12mm	 6 x 15mm	 6 x 20mm	 6 x 25mm



M 847-SK sw	M 848-SK gr/sw		
 6 x 30mm	 6 x 40mm		

M 849-SK gr/sw		M 850-SK gr/sw	
 6 x 50mm		 7 x 10mm	

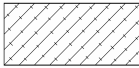
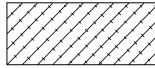
Profile als Montagehilfe einseitig selbstklebend auf der Breitseite ausgerüstet

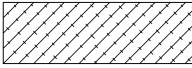
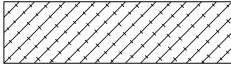
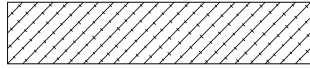
	M 776-SK gr/sw	M 762-SK sw	M 777-SK sw	M 1202-SK gr/sw	M 851-SK gr/sw
	 8 x 8mm	 8 x 10mm	 8 x 12mm	 8 x 18mm	 8 x 20mm

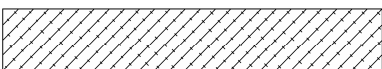
M 773-SK gr/sw	M 852-SK sw	M 853-SK sw
 8 x 25mm	 8 x 30mm	 8 x 40mm

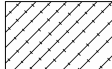
M 854-SK gr/sw	M 749-SK sw	M 855-SK gr/sw	M 748-SK sw
 8 x 50mm	 10 x 10mm	 10 x 12mm	 10 x 15mm

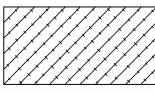
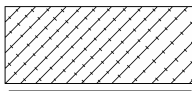
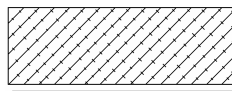
M 774-SK sw	M 856-SK sw	M 857-SK sw	
 10 x 20mm	 10 x 25mm	 10 x 30mm	

Profile als Montagehilfe einseitig selbstklebend auf der Breitseite ausgerüstet

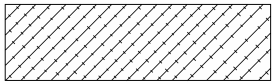
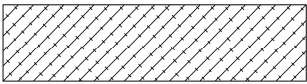
M 858-SK gr/sw	M 859-SK sw	
 10 x 35mm	 10 x 40mm	

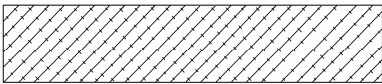
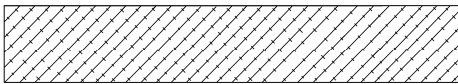
M 861-SK sw	M 862-SK gr/sw
 10 x 50mm	 10 x 60mm

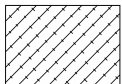
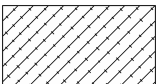
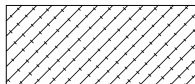
M 760-SK sw	M 863-SK gr/sw	M 772-SK gr/sw	M 864-SK sw	
 12 x 12mm	 12 x 15mm	 12 x 20mm	 12 x 25mm	

M 867-SK sw				
 12 x 40mm				

Profile als Montagehilfe einseitig selbstklebend auf der Breitseite ausgerüstet

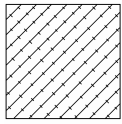
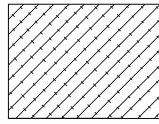
M 771-SK sw	M 745-SK sw				
 15 x 15mm	 15 x 20mm				

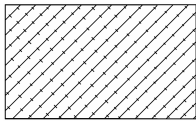
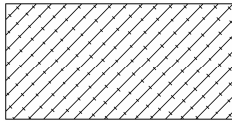
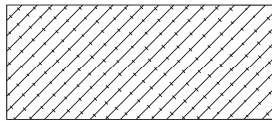
M 869-SK sw	M 870-SK sw	M 871-SK gr/sw
 15 x 25mm	 15 x 30mm	 15 x 35mm

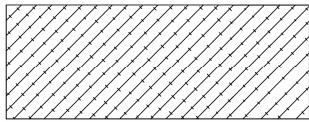
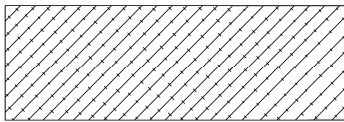
M 872-SK sw	M 873-SK gr/sw		
 15 x 40mm	 15 x 45mm		

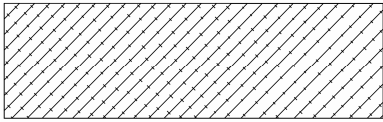
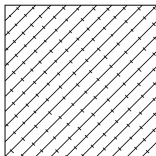
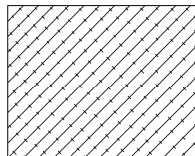
M 874-SK gr/sw	M 875-SK sw	M 876-SK sw
 15 x 50mm	 20 x 20mm	 20 x 25mm

Profile als Montagehilfe einseitig selbstklebend auf der Breitseite ausgerüstet

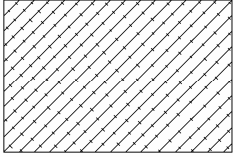
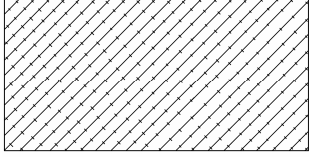
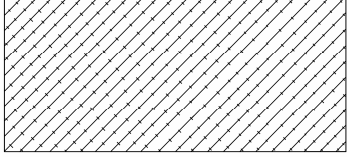
M 877-SK sw	M 879-SK sw	M 880-SK gr/sw
 20 x 30mm	 20 x 40mm	 20 x 45mm

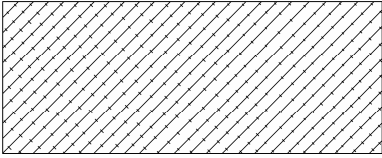
M 881-SK gr/sw	
 20 x 50mm	

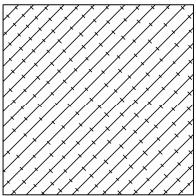
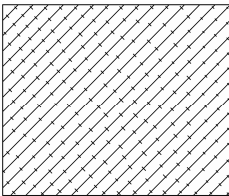
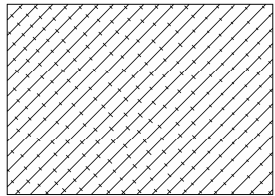
M 882-SK sw	M 883-SK gr/sw	M 884-SK gr/sw
 25 x 25mm	 25 x 30mm	 25 x 35mm

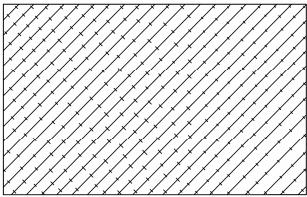
M 885-SK gr/sw		
 25 x 40mm		



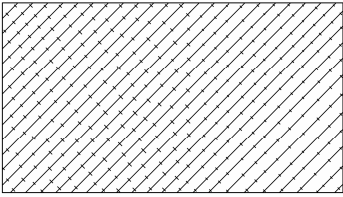
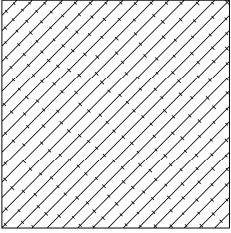

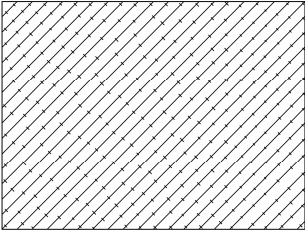
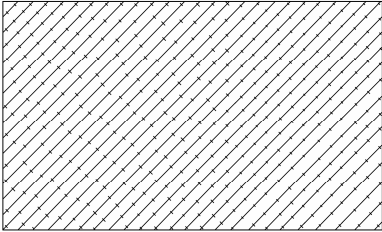

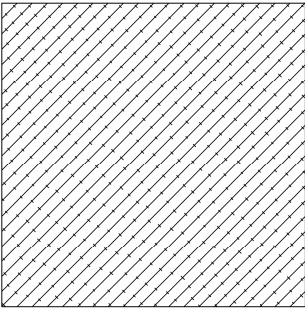
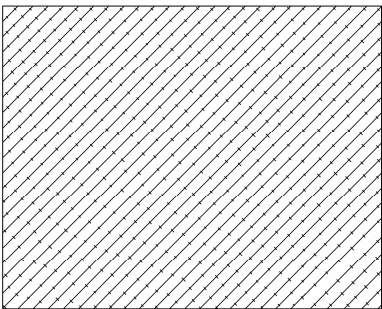
Profile als Montagehilfe einseitig selbstklebend auf der Breitseite ausgerüstet







M 886-SK sw	M 888-SK gr/sw
 <p data-bbox="432 689 544 719">25 x 45mm</p>	 <p data-bbox="1050 710 1161 739">30 x 30mm</p>







M 890-SK sw	M 892-SK gr/sw
 <p data-bbox="432 1220 544 1249">30 x 40mm</p>	 <p data-bbox="1050 1220 1161 1249">30 x 50mm</p>







M 896-SK gr/sw	M 897-SK gr/sw
 <p data-bbox="432 1778 544 1807">40 x 40mm</p>	 <p data-bbox="1050 1778 1161 1807">40 x 50mm</p>







Profile als Montagehilfe einseitig selbstklebend auf der Breitseite ausgerüstet







R 2336 br/w	R 1143	R 906 w	R 1311 w	R 1343 w	R 532 sw
 10mm Falz 2,8mm Nut	 10mm Falz 3mm Nut	 10mm Falz 4mm Nut	 10mm Falz 4mm Nut	 2,5mm Nut	 4mm Nut





R 934 br/w	RT 1 be/br/gr/sw/w	R 911 br/w	R 911-A br/w	RT 4 be/br/gr/sw/w	R 919 w
 11mm Falz 4mm Nut	 12mm Falz 4mm Nut	 12mm Falz 4mm Nut	 12mm Falz 4mm Nut	 12mm Falz 4mm Nut	 12mm Falz 4mm Nut







RT 2 be/br/gr/sw/w	RT 3 w	R 9501 br/w	R 996 be/br/w	R 909 br/w	R 2305 be
 12mm Falz 4mm Nut	 12mm Falz 4mm Nut	 12mm Falz 4mm Nut	 12mm Falz 4mm Nut	 12mm Falz 4mm Nut	 12mm Falz 4mm Nut







R 902 w	R 910 w	R 923 br/gr/w	R 1115 br/w	R 1062 w	R 8547 w
 12mm Falz 4mm Nut	 12mm Falz 4mm Nut	 12mm Falz 4mm Nut	 12mm Falz 4mm Nut	 12mm Falz 4mm Nut	 12mm Falz 3,5mm Nut





R 1927 br/w	R 2520	R 1523 br/w	R 915 br/sw/w	R 927 be/br/w	R 1046 w
 12mm Falz 2,8mm Nut	 12mm Falz 3mm Nut	 12mm Falz 3mm Nut	 12mm Falz 2,8mm Nut	 12mm Falz 2,8mm Nut	 12mm Falz 3mm Nut





R 1499	R 2017 w	R 1231 be/br/w	R 940 be/br/w	R 1415	R 915-A br/sw/w
 12mm Falz 3mm Nut	 12mm Falz 3mm Nut	 12mm Falz 2,8mm Nut	 12mm Falz 2,8mm Nut	 12mm Falz 4mm Nut	 11mm Falz 2,8mm Nut







R 924 br/w	R 925	R 939 br/w	R 931 br/w		R 8615
 12mm Falz 2,8mm Nut	 12mm Falz 3,5mm Nut	 3,2mm Nut	 12mm Falz 2,8mm Nut		







R 926 br/w	R 917	R 937 gr	R 1886		R 8628 w
 12mm Falz 4mm Nut	 12m Falz 4mm Nut	 12mm Falz 4,5mm Nut	 12mm Falz 2,5mm Nut	 ersetzt durch R 8628	 verbesserte Version







R 1904 br/w	R 914 br/w	R 942-A w	R 905 br/w	R 1908 be/br/w	R 904 br/w
					
14mm Falz 4mm Nut	14mm Falz 4mm Nut	14mm Falz 4mm Nut	14mm Falz 4mm Nut	14mm Falz 4mm Nut	14mm Falz 4mm Nut







R 935 sw	R 938 gr		R 9502 br/w		R 8807 w
					





R 1817			R 2145 br/w	R 1262 w	R 1916 w
					
19mm Falz 4mm Nut				2,8mm Nut	16mm Falz 4mm Nut





R 918 tr	R 932 tr	R 932 sw	R 920 tr	R 950 tr	R 984
					
PVC	PVC	TPE	PVC	PVC	

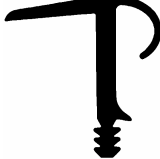

R 986 sw	R 1980	R 2307	R 2321	R 900	R 1565
					



R 1227 sw	R 527 tr	R 527-B tr	R 1449	R 2061	R 968 sw
					





R 2521 sw	R 1407 sw	R 2504	R 2063	R 1803	R 8537 sw
					





R 992		R 1390 w	R 1990 w		R 892
					





RF 2 be/br/sw/w	R 715 sw	R 641 sw	RÜ 1250 sw	F 62 (2 Komponenten-Profil) br/sw/w
 12mm Falz 5mm Nut	 12mm Falz 5mm Nut	 12mm Falz 5mm Nut	 12mm Falz 5mm Nut	 12mm Falz 4 – 5mm Nut Rücken EPDM hart Kopf Moosgummi

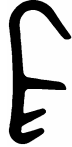





RF 3 br/rbr/sw/w	R 1749	RF 12 sw		F 60 (3 Komponenten-Profil) be/br/gr/sw/w
 12mm Falz 5mm Nut	 12mm Falz 5mm Nut	 12mm Falz 5mm Nut		 12mm Falz 5mm Nut 8mm Kopfbreite Rücken hart Kopf weich Fußlippen weich





F 125 (3 Komponenten-Profil) be/br/gr/sw/w	F 70 (3 Komponenten-Profil) be/br/gr/sw/w	FSW 125 (3 Komponenten-Prof.) be/br/gr/sw/w
 12mm Falz 5mm Nut 8,5mm Kopfbreite Rücken hart Kopf weich Fußlippen weich	 12mm Falz 5mm Nut 8,5mm Kopfbreite Rücken hart Kopf weich Fußlippen weich = Superweich !	 12mm Falz 5mm Nut 9mm Kopfbreite Rücken hart Kopf weich Fußlippen weich = Superweich !





RF 22 sw	RF 23 sw	FSW 103 (3 Komponenten-Prof.) an/be/br/gr/sw/w	FSW 123 (3 Komponenten-Prof.) an/be/br/gr/sw/w
 12mm Falz 5mm Nut	 12mm Falz 5mm Nut	 10mm Falz 3mm Nut 8,5mm Kopfbreite Rücken hart Kopf weich Fußlippen weich = Superweich !	 12mm Falz 3mm Nut 8,5mm Kopfbreite Rücken hart Kopf weich Fußlippen weich = Superweich !



RF 9 sw/w	RF 10 br/sw/w		R 2303 sw		R 2198 sw
					
12mm Falz 4mm Nut	12mm Falz 4mm Nut		12mm Falz 4mm Nut		





RF 13 br/sw	RF 7 sw	RF 21 sw		RF 24 sw	RF 11 br/sw/w
					
10mm Falz 4mm Nut	10mm Falz 4mm Nut	10mm Falz 4mm Nut		10mm Falz 5mm Nut	10mm Falz 5mm Nut



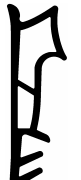

R 1240	R 1340 br/w	R 1430 sw/w	R 883 sw	RF 8 sw/w	R 2030 br/w
					
7mm Falz 3,5mm Nut	8mm Falz 4mm Nut	9mm Falz 3mm Nut	10mm Falz 3,5mm Nut	12mm Falz 3mm Nut	15mm Falz 3mm Nut



R 1950 sw	R 2045	R 1540 sw			R 1542 gr
					
14mm Falz 5mm Nut	15mm Falz 4,5mm Nut	15mm Falz 4mm Nut			10mm Falz 3mm Nut





R 2050	RF 4 rbr/sw/w	F 155 (3 Komponenten-Profil) be/gr/rbr/sw/w	FSW 155 (3 Komponenten-Prof.) be/gr/rbr/sw/w
 15mm Falz 5mm Nut	 15mm Falz 5mm Nut	 15mm Falz 5mm Nut 8,5mm Kopfbreite Rücken hart Kopf weich Fußlippen weich	 15mm Falz 5mm Nut 9mm Kopfbreite Rücken hart Kopf weich Fußlippen weich = Superweich !



			R 2150		R 2240 sw
			 16mm Falz 5mm Nut		 17mm Falz 4mm Nut





R 1840 sw	RF 5 br/sw/w	F 185 (3 Komponenten-Profil) be/gr/rbr/sw/w	FSW 185 (3 Komponenten-Prof.) be/gr/rbr/sw/w
 18mm Falz 4mm Nut	 18mm Falz 5mm Nut	 18mm Falz 5mm Nut 8,5mm Kopfbreite Rücken hart Kopf weich Fußlippen weich	 18mm Falz 5mm Nut 9mm Kopfbreite Rücken hart Kopf weich Fußlippen weich = Superweich !







RF 14 br/sw/w	R 2040 sw	R 2340 sw	RF 19 sw		
					
15/18mm Falz 5mm Nut	15mm Falz 4mm Nut	18mm Falz 4mm Nut	20mm Falz 4mm Nut		





			R 2035	R 2041 br/sw/w	R 2341 sw
					
			15mm Falz 3,5mm Nut	15mm Falz 4mm Nut	18mm Falz 4mm Nut







R 607	R 642 sw		R 1599 br/sw/w	R 2335	
 4mm Nut	 5mm Nut				





R 1084 sw		R 2564 sw			
					







R 1108		R 1737 sw	R 548 tr	R 1111 tr	R 1992 br
 5mm Nut		 4mm Nut	 4,5mm Nut	 5mm Nut	 5mm Nut







R 1935	R 1936	R 1936-A br/sw/w	R 1169	R 2502 sw/w	R 2519 sw/w
 3mm Nut	 3mm Nut	 3mm Nut	 3,5mm Nut	 3mm Nut	 3mm Nut







R 2505 sw/w	R 2115	R 1498 br	R 1814 sw		R 2134 sw
 3mm Nut	 3mm Nut	 2,5mm Nut	 2,5mm Nut		







R 669 gr	R 1173	R 972 sw	R 941	R 1802 sw	R 651
					







R 796		R 8750 sw	R 8782 be	R 974 br	R 1496 br
					





RF 18 sw	RF 25 sw	RF 26 sw	RF 17 sw	RF 15 sw	R 1452
					
13mm Falz 5mm Nut	15mm Falz 5mm Nut	18mm Falz 5mm Nut	19mm Falz 5mm Nut	20mm Falz 4mm Nut	





R 722 tr	R 522 w	R 662	R 1815 sw	R 795 sw	R 8624 gr
					

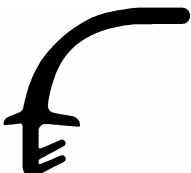

R 834	R 2001 sw	R 1998	R 1777 sw	R 590	R 646
					





R 1461 sw	R 515 sw	R 502	R 586 sw	R 558 tr	R 576 w
					

R 1481 sw	R 8781 gr	R 8675 sw	R 8836 sw	R 971 sw	R 971-A sw
					



R 816	R 565 w	R 2106	R 1107 sw	R 945
				





R 1097	R 8657 sw	R 8723 sw	R 8689 sw		
					







		R 973 sw	R 1957 sw		R 8803 sw
					







R 903 SW	R 8634 SW	R 1584 SW	R 8610		R 8845 SW
					





R 1830 SW					
					



R 810 SW	R 865 SW				
					

R 1195	R 1963 SW	R 1432 SW	R 2036		
					

R 749	R 516 tr	R 8621 gr	R 1473	R 1043	R 591 sw
					

R 1444 gr	R 1187 sw	R 729	R 1987	R 1047 sw	R 8761 sw
					

R 1463 sw		R 2450 sw	R 8879 sw	R 2539	R 2122
					

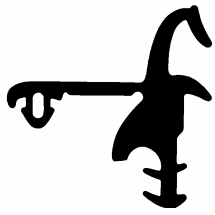

R 572 tr	R 639 tr	R 1350	R 2130
			



R 1282 sw	R 600 sw	R 1109 sw	R 2346	R 847 sw	R 1843



R 1913	R 2087	R 1112 sw	R 2048 sw	R 1150	R 8528

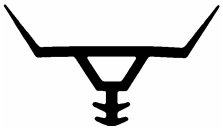

R 1891	R 8510	R 1013	R 1866	R 1863	R 1176 sw





R 8732 sw	R 1956 sw	R 8630 sw	R 970 sw	R 602	R 739



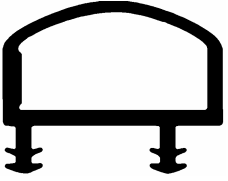

R 1405	R 1489	R 1489-A	R 1330 sw	R 1867
		k. A.		





R 951		R 1290		R 1812
				





R 8738			R 2138
			

R 2313		R 8719		R 2366
				







R 1760		R 806	R 1587 SW	R 1161	
					

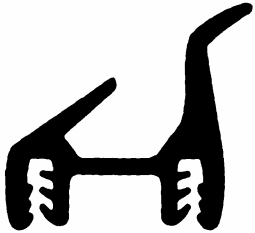





R 552 SW		R 1144 SW	R 592		R 1470 SW
					







R 2095	R 2059		R 549 SW		R 2104 SW
					







R 1951		R 1581	R 1900	R 1782 SW
				





R 2304	
	





R 2096	R 2526 gr	R 8617 sw	R 8767	R 644 tr	R 716 gr
					



R 821 sw	R 2359	R 1874	R 8513 sw	R 8866 sw	R 8664 sw
					





R 832 w	R 1766 w	R 885 sw	R 1770	R 8531	R 1778 sw
					



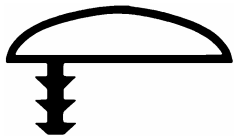

R 864	R 2517 gr	R 560 sw	R 1753 sw	R 1937	R 1309
					





R 1397		R 627 sw	R 1255	R 1249	R 1245
					







R 1379	R 1947	R 824	R 825 sw	R 2088
				





R 8609 sw	R 2518	R 8736	R 2099
			







R 8546 sw	R 8751 sw	R 8643		R 1006
				





R 1417-A rbr/sw	R 676 sw		R 1417		R 2108
					





R 1938 sw	R 1339	R 1828	R 2125 sw		R 1897
					





R 1914 sw	R 827 sw	R 8876 sw	R 1800 sw	R 800 sw	R 1519
					



R 1127	R 2127	R 1848		R 1370	R 1001 br/w
					





R 1784	R 1235	R 508	R 1242 SW	R 1352	R 2327
					

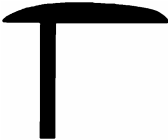

R 1971	R 1972	R 1445	R 8797 SW	R 1455	
					

R 1244 SW	R 601		R 2007	R 1100 SW	R 964
					

R 946	R 1000			R 881	R 1348
					

R 1394		R 1082		R 1369	
					

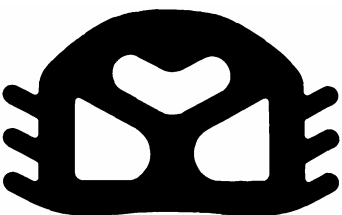
R 2109	R 1854		R 1882	R 1974	R 8616
					

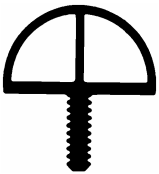
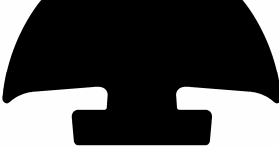

R 2317	R 2184	R 1889
		

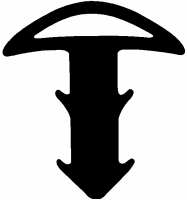
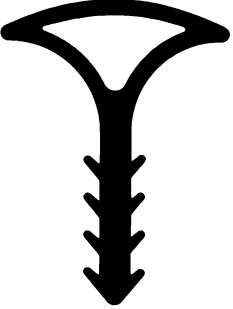
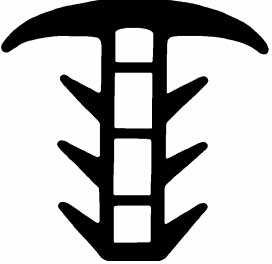

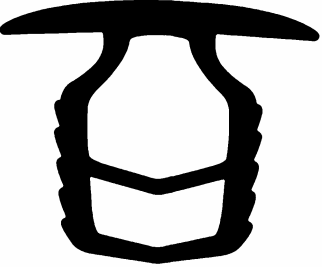
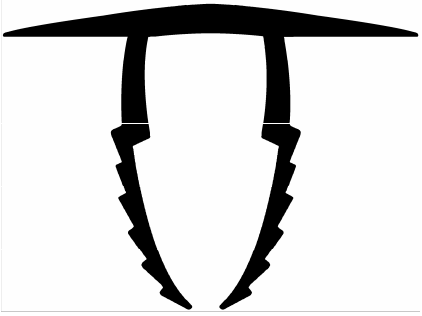
R 1818				R 8837 gr/sw
				

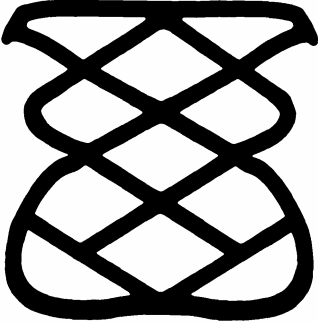

R 1226 sw	R 956		R 1209 sw
			



R 1106	R 8873 gr/sw
	



	R 2330
	

R 1583	R 1076
	

R 1553	R 1825
	

R 975 SW	R 1765
	

R 1966		R 2082
		

<p>R 2117 lichtgrau</p>	<p>R 8832 sw</p>
 <p>60mm</p>	

<p>R 2306 lichtgrau</p>	
 <p>80mm</p>	

<p>R 2133</p>	
 <p>100mm</p>	

R 871 tr	R 543 gr/sw	R 538 sw	R 657 sw	R 581 sw	R 582

R 1117	R 1256 sw	R 1033	R 8835 sw	R 1993 gr	R 1805 sw

R 655 sw	R 593 sw	R 670 sw	R 856 gr	R 1175	R 569







R 747 sw	R 748	R 2301	R 820 gr	R 1157	R 1157-A sw





R 2039	R 1474 sw	R 2083	R 746	R 618	R 546 sw





R 1918 sw	R 2006	R 2375	R 8652	R 1598 sw	R 555 sw





R 649 sw	R 1989 sw	R 8804 sw	R 656 gr	R 8638 sw	R 1870





R 2032	R 1162 sw	R 509 tr		R 793	R 8534 sw





R 743 sw	R 836 sw	R 797	R 8717	R 8706	R 1546 sw
					





R 1024	R 652 sw	R 936 gr	R 1893 gr	R 2110	
					







R 619 gr	R 620 gr	R 898 sw	R 1742 sw		R 1019
					







R 1446	R 517	R 589 gr	R 597
			







R 853 SW	R 645 SW	R 645-A SW	R 645-B SW	R 2008 SW	
					





R 675	R 2148	R 2148-A SW	R 2368		R 703
					







R 805	R 571	R 2147 SW		R 8742
				

R 1360	R 1306 SW	R 1119 SW	R 1119-A SW	R 8709	R 8711
					

R 613 gr	R 2508 sw	R 1118 sw	R 2538	R 1934 sw	R 1887 sw
					

R 876 sw	R 1113 sw	R 1305	R 1795	R 1419	R 1251
					

R 1236	R 691 gr	R 1292	R 1844	R 2092
				

R 833	R 2086	R 1408 sw	R 1408-A sw	R 1283 sw	R 8806 sw
					

R 1566	R 1547	R 1593	R 704	R 887 gr	R 668 gr





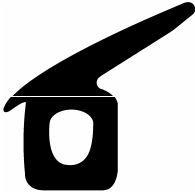

R 2089	R 1912	R 788	R 721	R 647	R 521

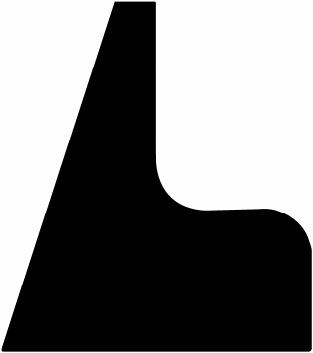





R 623	R 1158	R 1122	R 1353	R 594	R 1331







R 654		R 1020 sw	R 1557	R 750	R 534





R 8822 sw	
	



	R 8894 gr/sw
	

R 688 SW	R 1743 SW	R 708 SW	R 683 SW	R 1267 SW	R 1278
					



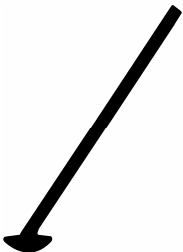

R 1411 SW	R 1237	R 1596	R 8823 SW	R 2349 SW	R 1278-A SW
					





R 8633	R 1915 SW	R 1457	R 1410	R 529	R 1057
					

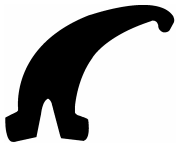



R 1497 SW	R 1497-B	R 519 SW	R 1277 SW	R 8758 SW
				





R 807 gr	R 612 gr	R 792			
					







R 622	R 1873			R 8619 sw	R 822
					







R 835	R 1483		R 8691 sw		R 1368 sw
					





R 1451	R 559	R 1447			R 2105
					





R 1298 sw	R 1861	R 1495	R 843 gr		
					







R 1995	R 2052	R 8759 sw	R 2384	R 535 gr	
					







R 1168	R 1116 sw	R 663 sw	R 723 sw	R 1114 sw	R 1172
					







R 1832 sw	R 616 sw	R 2338 sw	R 1023 sw	R 1268 sw	R 1192
					







R 1482	R 1291	R 1279	R 1234		
					







R 1148	R 523 tr	R 987 tr	R 959 tr	R 1154 sw	
					







R 976 gr	R 1071 sw	R 963	R 2523	R 1475 sw	R 1264
					

R 2389	R 1015	R 1819	R 1911	R 1248	R 2022
					

R 1791 sw	R 899	R 2053	R 2023	R 2021	R 2183
					





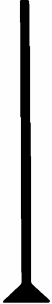

R 854	R 1014	R 8810 sw	R 2076	R 2079	R 896
					





R 701	R 702 tr	R 1380	R 1442 sw	R 1180	R 1322
					







R 505 sw	R 705 sw	R 706 tr	R 707	R 8673 sw	R 1967 sw
					







R 8515 gr		R 2069	
			





			R 8533
			







R 1003	R 1039 SW	R 1011	R 1021	R 849	R 1067
					





R 1036	R 1036-A SW	R 1160	R 1491	R 1773	
					

R 803 SW	R 1049 SW	R 672 SW	R 672-A SW	R 648 SW	R 648-A SW
					







R 804 SW	R 818 SW	R 542 SW	R 1943	R 1285	R 8773
					







R 614 tr	R 1208 tr	R 1479	R 1478		R 815
					





R 1190	R 626 sw	R 2098	R 8841 sw	R 1074	R 8768
					







R 526 tr	R 826			R 740	R 8650
					





					R 503
					



R 2077 gr	R 2077-A	R 628 tr	R 605 sw	R 1170	R 570 sw
					







R 1081	R 1401	R 1018	R 733 sw	R 851 sw	R 2140
					





R 2118	R 8743 sw	R 873 sw			R 8682 sw
					







R 1754	R 1838	R 2025	R 1590	R 1849 sw	R 1774 sw
					







R 8756 sw	R 1847 sw	R 693 gr	R 895 sw	R 8780 sw	
					







R 1781	R 8794 sw				
					







R 1726 SW	R 1153 SW	R 8749 SW	R 610 SW	R 1707 SW	R 8755 SW
					







R 879 SW	R 1710 SW	R 1317 SW	R 1903 SW		R 2528 SW
					







R 8883 SW	R 1594 SW	R 1728 SW	R 1727 SW	R 1736 SW	R 8811 SW
					

R 1304 SW	R 8869 SW	R 860 SW	R 1744 SW	R 730 SW	R 2460 SW
					

R 852 SW	R 1783 SW	R 1731 SW	R 1729 SW	R 1732 SW	R 2167
					







R 1588	R 2527 SW	R 8798 SW	R 1738 SW	R 1741 SW	R 8523 SW
					







R 1156 SW	R 1261 SW	R 557 SW	R 1259 SW	R 1259-A SW	R 8613 SW
					







R 1864 SW	R 1321 SW	R 1321-A SW	R 869 gr	R 520 SW	R 689 SW
					





R 8842		R 2436 SW			







R 8824 SW					





R 1708 SW	R 1724 SW	R 1735 SW	R 842 SW	R 1985 SW	R 8661 SW
					



R 1389 SW	R 2333 SW	R 2395	R 1383 SW	R 8620	R 1186 SW
					







R 8639	R 8651 SW	R 8752 SW	R 8707 gr	R 8747 SW	R 8733 SW
					





R 1589	R 8606	R 2043	R 1073		R 8796 SW
					





R 1768	R 1299 SW	R 1739 SW	R 1725 SW	R 1711 SW	R 1246 SW
					







R 1423 SW	R 1751 SW	R 2545 SW		R 8766 SW	
					





R 8870 SW	R 8871 SW				R 8868 SW
					





R 1265	R 1206 SW	R 2525 SW	R 1702	R 2571 SW	R 8725 SW
					





R 2547 SW	R 2546 SW	R 1705 SW		R 2548 SW	R 2549
					







R 2066	R 1747 SW		R 1734 SW	R 1733 SW	R 1152
					





R 1752 SW	R 2503 SW	R 1746 SW	R 1302 SW	R 8765 SW	R 8763 SW
					





R 1125 SW	R 1387 SW		R 2081		R 8787 SW
					



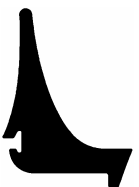

R 719	R 718		R 858	R 858-A SW	R 1257
					



R 8622	R 8679	R 8654		R 8683	
					





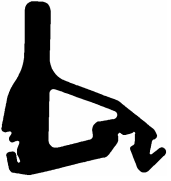
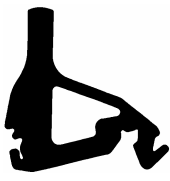

R 8864 SW	R 1757 SW	R 799 SW	R 1328	R 8777 SW	R 8712
					







R 1376 SW	R 717 SW	R 717-A SW	R 1809		
					





R 698		R 1200	R 1200-A SW		R 1398
					







R 2024	R 2024-A	R 1982	R 967	R 1064	
					



R 1134	R 8840 SW		R 8815 SW	R 8648
				



R 1165 SW	R 1254 SW	R 2034 SW	R 801	R 1381 SW	R 8529 SW
					







R 621 SW	R 2343 SW	R 2067 SW	R 514 SW	R 513 SW	R 891 SW
					







R 872 SW	R 1876 SW	R 875 SW	R 2016 SW	R 8641 SW	
					







R 2536 SW	R 680	R 2356	R 2056 SW	R 1361	R 1467
					





R 8800 SW		R 8826 SW		R 8846 SW	
					

	R 8857 SW			R 1807	R 1807-A SW
					

R 1135 SW	R 595 SW	R 2026	R 1796 SW	R 8779	R 1101
					

R 1183 SW	R 823	R 1210 SW	R 1155	R 1788	R 1280 SW
					

R 8724 SW	R 8793 SW	R 2173	R 1068	R 8705	R 8708
					

R 751 SW	R 1954 SW		R 850	R 850-A SW	R 8601
					



R 2342			
			





R 687 SW	R 1045 SW	R 686 SW	R 1286	R 8805 SW	R 8690 SW





R 1571	R 611	R 1329	R 837	R 845	R 637



R 1965 SW	R 1364	R 556	R 814	R 8789 SW	R 580







R 1061	R 2386	R 1314 SW	R 1961 SW	R 1307 SW	R 2107







R 1450		R 1058		R 1462	
					







R 1439 SW	R 1414 SW			R 606 SW	R 1179
					





R 8838 SW	R 8838-A SW		R 674		R 2534
					







R 635 SW	R 1877	R 2345			
					





R 1199	R 2068	R 8503	R 2544	R 742	R 1418
					



R 878	R 2373	R 8851 sw	R 8720	R 1436 w	R 2080
					

R 528 sw	R 596	R 667 gr	R 1769 sw	R 8694 sw	R 866 sw
					

R 727	R 624 tr	R 574 tr	R 8762 sw	R 2309
				

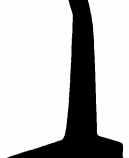

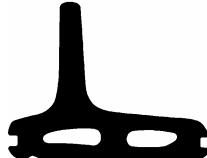

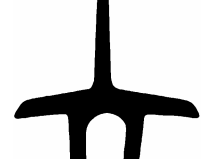

R 1591	R 1548 sw	R 1845	R 700	R 699	R 1493 sw
					







R 8508	R 8540 sw	R 1775	R 8517	R 2361	R 2362
					







R 2355	R 2143	R 2144
		







R 1568 sw		R 1895
		







R 8746			
			





R 1149 sw	R 870 sw	R 633 sw	R 537 sw	R 696 gr	R 2522
					





R 725 sw	R 868 sw	R 8629	R 724 sw	R 8772 sw	R 8701 sw
					





R 629 w	R 711 w	R 1228	R 855 w	R 8642	R 8776 sw
					

R 2364	R 863 sw	R 1872 sw	R 1104 sw	R 1139 sw	R 1139-A
					





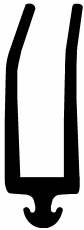

R 536	R 2506	R 726	R 2012	R 829 sw	R 677 sw
					







R 874	R 1080	R 1230	R 897	R 8526
				







R 993	R 882	R 1978	R 8744	R 1958
				







R 512 sw	R 2046 sw	R 650 sw	R 566 sw	R 1040	R 8760 sw
					







R 8544					
					







R 1325	R 1092 SW	R 1890	R 741	R 1224	R 1758
					







R 894 SW	R 1763	R 1269	R 1492 SW	R 1166 SW	R 2120
					





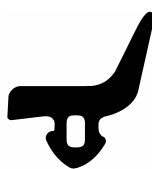

R 1704 SW	R 1070	R 8801 SW	R 1319	R 8511	R 2379 SW
					

R 886 SW	R 1185 SW	R 575 SW	R 2507 SW	R 1077 SW	R 1494
					

R 2074	R 2074-A sw	R 1837	R 530 gr	R 578 sw	R 1538 sw
					

R 583	R 1964	R 862	R 861 sw	R 861-A sw	R 8847 sw
					

R 8721	R 8778 sw	R 8757 sw	R 664	R 1420	R 817
					





R 8698	R 2075	R 714	R 673	R 1786 sw	R 2121
					





R 1346	R 540	R 1454 sw	R 1425 sw	R 1164 gr	R 794





R 1316	R 8726	R 1779	R 2114 sw	R 1308 sw	R 1811







R 2129	R 1301	R 1703 sw	R 2347	R 8522	R 1258





R 709 sw	R 1448 sw	R 1434 sw	R 2124 sw	R 2363	R 692

R 518 SW	R 1310 SW	R 2141 SW	R 8790 SW		R 8753 SW
					



R 1862 SW	R 1883 SW		R 8812 SW		R 1347
					



R 8608 SW	R 2044 SW	R 1833 SW	R 1357	R 8740 SW	
					





R 2037	R 1124 SW	R 1124-A SW	R 2071 SW	R 1476	R 1093 SW
					





R 615 gr	R 577 sw	R 2073 sw	R 1315		
					

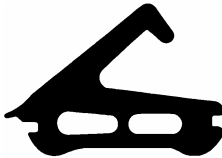





R 2381					
					







R 8538 sw	R 8603	R 8809 sw			
					







R 8829 sw					R 2326
					







R 2111	R 2011 SW	R 1459	R 1459-B SW
			







R 2372 SW	R 2339 SW	R 1323	R 2357 SW
			







R 893	R 1841 SW	R 8681 SW	R 8791 SW	R 1205 SW	R 2018 SW
					







R 1764	R 1945 SW	R 2496 SW	R 2396	R 2391	R 8685 SW
					





R 744	R 738 SW	R 1906	R 8672 SW	R 2055 SW	R 2054
					





R 1792 SW	R 1488 SW	R 1917 SW	R 1402	R 1767 SW	R 8668 SW
					





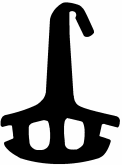

R 857 SW	R 1976 SW	R 1976-A SW	R 1079	R 2027 SW	R 8862 SW
					





R 1458 SW	R 1443 SW	R 1443-A SW	R 916	R 2358 SW	R 1840-B
					



R 1211 SW	R 1831	R 841 SW	R 1960	R 8618 SW	R 598
					

R 812	R 8631 SW	R 1554		R 640 SW	R 1804
					



R 2042	R 2139 SW	R 8627	R 8784 SW		R 1486
					





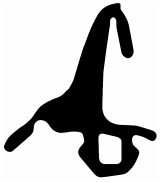
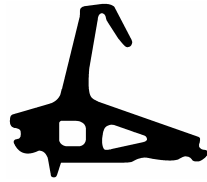

R 1171	R 8697	R 2320 SW	R 1780 SW	R 8774 SW	R 1239 SW
					



R 846 SW	R 1372 SW	R 1997		R 8535 SW	
					



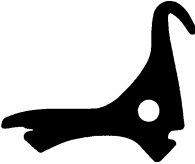

R 1979	R 1884 SW	R 1327 SW
		

R 1953 SW	R 8718	R 8714 SW
		



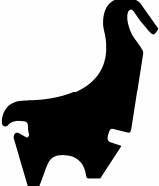

R 665 tr	R 789				
					

R 1178 SW	R 952 SW	R 1303	R 8702 SW	R 1810 SW	R 728
					

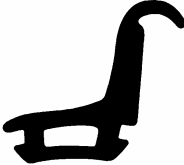
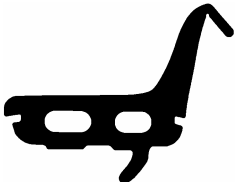
R 2049	R 1856	R 8623 SW	R 2540 SW
			

R 1994	R 1986 SW	R 8520 SW	R 2010	R 1004	R 8704
					



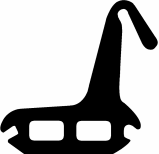

R 1356 SW	R 2325 SW	R 1233 SW
		



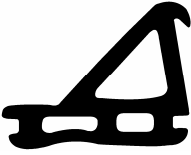



R 8710 SW	R 8748 SW	R 8878 SW	R 8754 SW		R 8863 SW
					





R 8792 SW		R 8802 SW			
					



R 8872 SW					
					







				R 8839 SW
				







R 712 tr	R 573 gr		R 2149		R 531
					







R 988 tr	R 1151 sw	R 1188	R 1159	R 962 sw	R 957 sw
					







R 1564	R 1857	R 666	R 1820	R 1885	
					







R 1243					R 991 sw
					





R 1038	R 1181	R 960 SW	R 1065 SW	R 1066 SW	R 1776
					





R 2337	R 1556	R 713	R 1177 SW	R 1174 SW	R 1585
					





R 2509	R 8545	R 1284 SW	R 1069 SW	R 1126 SW	R 8731
					



R 501	R 533	R 2524 SW	R 965	R 562	R 1899
					

R 1988	R 1147	R 1281	R 1772	R 1875	R 2302
					

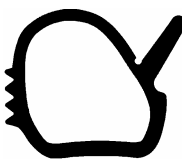

R 1942		R 8519	R 2028		R 8855 sw
					

R 506 sw	R 541	R 2091		R 1391
				

R 1295	R 2178	R 1558	R 1946
			

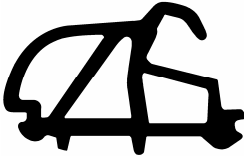
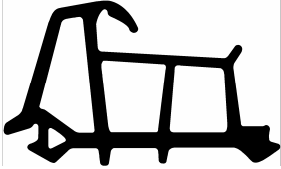





R 989 sw	R 979 gr	R 980 gr
		

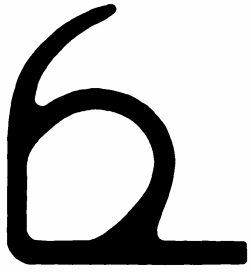





R 8882 sw	R 8886 sw	
		







R 2512		R 2113
		







			R 2318
			

R 1312	
	





R 859 SW	R 2531 SW	R 2529 SW	R 1959 SW	R 2541	R 1194 SW
					



R 1293	R 1422 SW	R 1561 SW	R 8745 SW	R 1456	R 8700 SW
					

R 1008 SW/W	R 1416	R 2532 SW	R 1424 SW	R 1424-A SW/W	R 1905 SW
					





R 1969	R 2533 SW	R 2530 SW	R 8795 gr/sw	R 1712 SW	R 710 SW
					

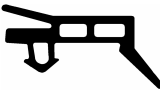

R 8859 w	R 8865 sw				
					





R 2542 gr	R 2331 gr	R 1429 gr	R 890		R 1433 gr
					



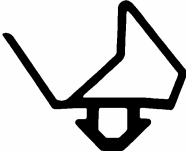
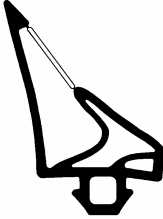

R 1137 gr	R 1145 gr				
					





R 8856 sw					R 8814 gr
					





R 685 sw	R 8607	R 8833 sw	R 8771 w		R 8834 sw
					





R 1586 gr	R 1366	R 2084	R 2072 gr
			





R 921 sw		R 929 sw	R 1559 sw	R 1999	R 1808
					







R 961 gr	R 2354 gr	R 1365	R 1983	R 1393 sw	
					







R 1816	R 1855	R 2322			R 8504
					







R 8867 sw	R 690	R 507	R 2312 sw		R 550
					



R 977 gr	R 982 gr	R 1300		R 943	R 1025
					





R 1798 sw	R 1789 gr	R 1790		R 8735
				



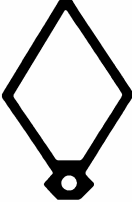

R 630	R 8884 sw	R 1902	R 969 sw	R 8788 sw	R 983 gr
					

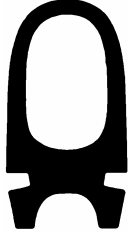



R 1426 gr	R 1713 sw	R 1428	R 8881 sw	R 1232	R 1332
					







R 1276	R 2058 sw	R 2390	R 1421 gr	R 564	R 2369
					





R 1392		R 2135		R 2182	R 2181
					



R 737	R 1595	R 981 sw	R 1981 sw	R 2097
				

R 2510	R 2078	R 8786 sw	R 585 sw	R 1813	
					

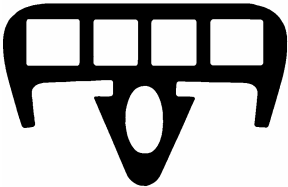
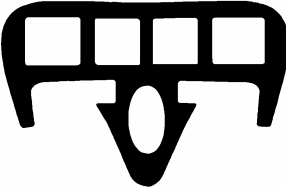
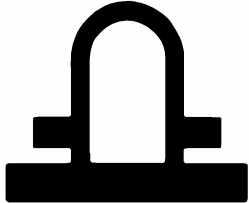

R 2537		R 1197	R 8850	R 2128 sw	R 1894 sw
					

R 1053	R 8636	R 636 sw	R 679	R 504	R 888 sw
					

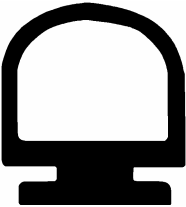
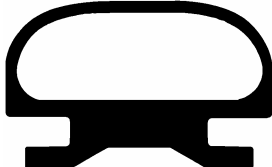
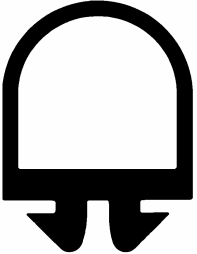
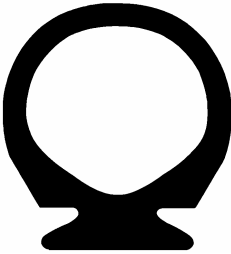
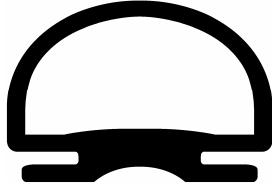
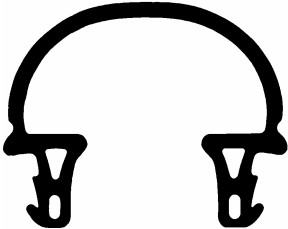
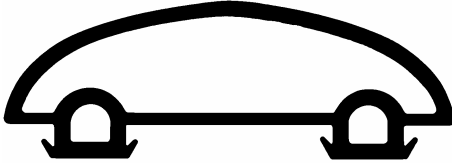

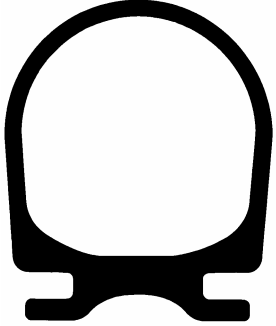
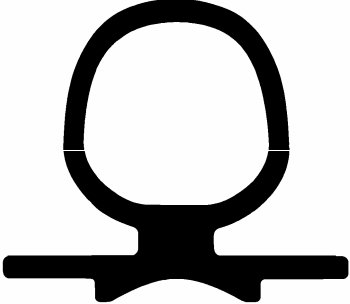

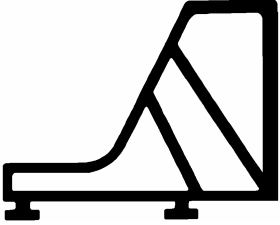
R 1852 sw/w	R 1829			R 1128	R 1146 sw
					

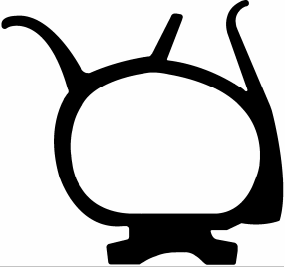
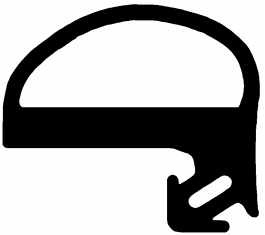

<p>R 1212 sw</p>	<p>R 2344</p>	<p>R 2371 sw</p>
		
<p>R 990</p>	<p>R 1896 sw</p>	<p>R 1163 sw</p>
		
<p>R 994 sw</p>	<p>R 2019</p>	<p>R 8813 sw</p>
		
<p>R 1371 sw</p>	<p>R 953</p>	
		





<p>R 1138 sw</p>	<p>R 1005</p>
	







<p>R 1824</p>	<p>R 1563</p>
	







<p>R 8722</p>	<p>R 8880 gr/sw</p>		<p>R 2116</p>
			







R 2033	R 2136	R 2126 SW		R 1271 SW	R 1955 SW
					







R 848	R 1836	R 2353			
					

R 2015	R 877	R 1349	R 1349-A SW		
					







R 1055 gr	R 831 sw	R 1054 sw	R 1919	R 2334	R 880 sw
					







R 1892 sw	R 1490 sw	R 587 sw	R 671 sw	R 2004 sw	R 1929 sw
					







R 524 sw	R 539 sw	R 844 sw	R 1435 gr	R 8695	R 1289
					







R 731 sw/w	R 731-A sw	R 731-B w	R 8821 sw	R 599 sw	R 1794 sw
					



R 720 sw	R 1102				
					





R 2142	R 1048 SW	R 838 SW	R 735	R 2315	R 922 SW
					





R 1962 SW	R 944 SW	R 1427 SW	R 1827 SW	R 2131	R 1142 SW
					





R 839 SW	R 930	R 1949	R 2376	R 907	R 732 SW
					







R 1182 SW	R 1326	R 684 SW	R 8626 SW	R 8653	R 8625 SW
					







R 1136 sw			R 8635		R 8645
					







R 2511	R 958 gr	R 954		R 1868
				





R 1034	R 999	R 998	R 1059	R 1078	
					







R 1823	R 1075	R 2057	R 819
			

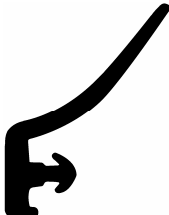





R 813	R 1354 SW	R 660 SW	R 694 SW	R 1220 SW	R 1756 SW
					







R 547	R 625	R 1270	R 8659 SW	R 653	R 1063 SW
					







R 1544 SW	R 2029	R 1297 SW	R 8693 SW	R 734	R 809
					







R 8887 SW	R 551 SW	R 2513	R 510	R 2155	R 8817 SW
					







R 1253 SW	R 661 SW	R 759 SW	R 759-A SW	R 1385 SW	R 2393 SW
					



R 1716 SW	R 760 SW	R 8632 SW	R 1056 SW	R 8604 SW	R 1842
					



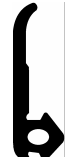

R 1975	R 1431	R 1907 SW	R 1098 SW	R 1714 SW	R 2399 SW
					



R 1552	R 584 SW	R 1260 SW	R 745 SW	R 787	R 1846
					





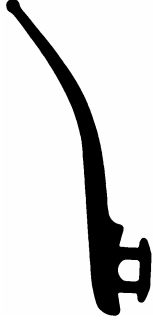

R 783	R 553 gr	R 8820 sw	R 1785	R 617	R 782
					







R 1042	R 1404 sw	R 8875 sw	R 8770 sw	R 8808 sw	R 840
					







R 8854 sw		R 8816 sw			R 1017 sw
					







R 1214 sw		R 8524 sw	R 1296 sw		R 8674 sw
					







R 1879		R 8843 sw
		







R 659 SW	R 634 SW	R 1238 SW	R 1217	R 1217-A SW	R 609
					





R 2314 SW	R 830 SW	R 1191 SW	R 1229 SW	R 2146 SW	R 758 SW
					





R 1247 SW	R 756 SW	R 2408 SW	R 828	R 658 SW	R 8649
					







R 1266	R 1026	R 1044	R 761 SW	R 1141 SW	R 8874 SW
					







R 1167 SW	R 1718 SW	R 754 SW	R 1715	R 1717 SW	R 757 SW
					





R 1318	R 1386 SW	R 8703 SW	R 753 SW	R 682 SW	R 8536 SW
					







R 1196 SW		R 8521	R 753-A SW	R 8860 SW	R 8612 SW
					





R 8539 SW		R 1140	R 2123 SW		R 1396
					

R 561 SW	R 1221 SW	R 2394	R 1105 SW	R 1218 SW	R 1121 SW
					







R 1215 SW	R 1085 SW	R 678 SW	R 678-A SW	R 1851 SW	R 1012
					





R 1399	R 608	R 8828 SW	R 8730 SW		
					







R 784	R 778 SW	R 2348 SW	R 2332 SW	R 8602 SW	R 1549
					







R 2169 SW	R 786 SW	R 786-A SW	R 8861 SW	R 1853 SW/W	
					







R 8825 SW					
					







R 643	R 1441 sw	R 579 sw	R 567 sw	R 2038	R 1771
					







R 604	R 8684	R 603	R 802		R 2323
					







R 1821	R 1131	R 8852 sw	R 8769 sw	R 1382 sw	R 1198
					





R 8877 w	R 1787 sw	R 1438 sw	R 889 gr	R 1562	R 770
					





R 1761 SW	R 1723 SW	R 1720 SW	R 1721	R 8541 W	R 1719 SW
					



R 1087 SW	R 767 SW	R 1086 SW	R 8644 SW	R 1722 SW	R 1933
					



R 1759	R 1089 SW	R 1088 SW	R 554 SW	R 8692	R 8660 SW
					





R 2060 SW	R 1219 SW	R 2156 SW	R 8844 SW	R 8671 SW	R 8716
					





R 2101	R 2324 SW	R 8827 SW		R 8848 SW	R 8849 SW
					







R 763	R 769	R 8525 SW		R 1022	R 1022-A SW
					





R 8677		R 8680 w		R 8696 SW	
					







R 8699 SW					R 8715
					







R 775 SW	R 764 SW	R 1009 SW		R 8637	R 1103
					





R 1793 SW	R 772 SW	R 773 SW		R 771 SW	
					





R 2100	R 2047	R 1184	R 695 SW	R 568 SW	R 790
					





R 768 SW	R 1225 SW	R 1223 SW		R 1709	R 1477
					



R 544	R 766 SW	R 765 SW	R 1010	R 545	R 681 SW
					





R 1797 SW	R 1094 SW	R 1094-A SW	R 2112 SW	R 1440 SW	R 955 SW
					

R 1968 SW	R 1970 SW	R 1213 SW	R 2093 SW		R 948 SW
					

R 1384		R 2328	R 2329 SW	R 8527	R 8662 SW
					

R 8663 SW	R 2103 SW		R 8819 SW	R 8885 SW	
					





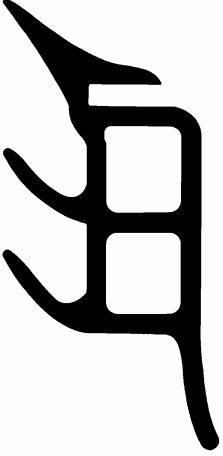

R 8734		R 8737			R 2308
					

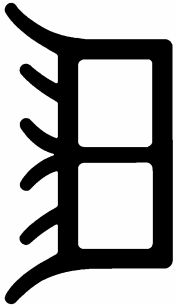

R 1706	R 762	R 1052	R 8858 SW		R 1406
					





					R 1991
					







R 1701			
			





			R 1320
			





R 632	R 1095 SW	R 2009	R 1403	R 1388 SW	R 1952
					





R 2311 SW	R 1437 SW		R 1822 SW		
					



R 1007 SW	R 2065	R 8505 SW	R 8506	R 1051 SW	
					





R 1940	R 1468 SW	R 1930	R 1941	R 1932 SW	R 1471 SW
					





R 1460 SW	R 774 SW	R 1096 SW		R 1030	
					

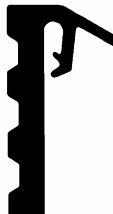

R 752		R 1313		R 1762 SW	R 1860
					





R 1939	R 8647		R 8741		R 8783 SW
					



R 1241 SW	R 1977			R 8713	
					

R 1207 sw	R 2543	R 631 sw/w	R 2535	R 1531	R 1931 sw
					

R 2090		R 2031	R 755	R 1572	R 1799
					

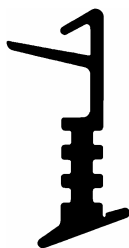

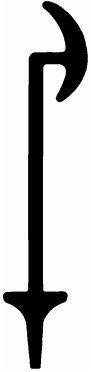



R 8614		R 8532		R 8853 sw	
					







R 2180		R 8543 sw	R 1041	R 779	R 780
					



R 2000		R 8831 gr/sw	R 1878
			







R 8678			
			







			R 1592
			







R 2070 sw	R 1667 sw	R 1944 sw	R 1668 sw	R 1669 sw	R 1555 sw
 4 x 2mm	 5 x 3mm	 5,5 x 2mm	 6 x 3mm	 7 x 4mm	 7 x 5mm

R 1670 sw	R 1671 sw	R 1324	R 1358	R 1672 sw	R 1673 sw
 8 x 4mm	 8 x 5mm	 9,5 x 4mm mit Schlitz	 9,5 x 4,2mm mit Schlitz	 10 x 6mm	 10 x 7mm

R 1674 sw			R 8518		
 12 x 8mm					





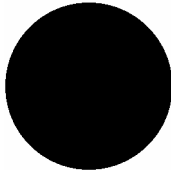
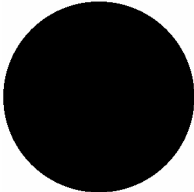

R 9600 sw	R 1697 sw	R 1692 sw	R 1693 sw	R 1694 sw	R 9601 sw
 2mm	 3mm	 4mm	 5mm	 6mm	 7mm

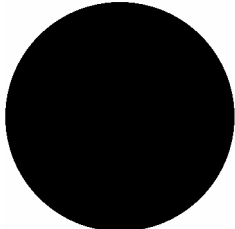
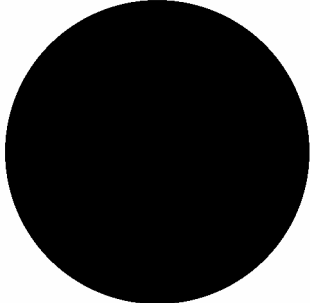



R 1695 SW	R 9602 SW	R 1696 SW	R 9603 SW	R 9604 SW	R 9605 SW
 8mm	 9mm	 10mm	 11mm	 12mm	 13mm





R 9606 SW	R 9607 SW	R 9608 SW	R 9609 SW	R 9610 SW	R 9611 SW
 14mm	 15mm	 16mm	 18mm	 19mm	 20mm



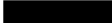
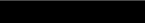

R 9612 SW	R 9613 SW
 <p data-bbox="454 674 517 696">22mm</p>	 <p data-bbox="1070 685 1137 707">25mm</p>





R 9614 SW	R 9615 SW
 <p data-bbox="454 1220 517 1243">30mm</p>	 <p data-bbox="1070 1256 1137 1279">40mm</p>



R 1639 sw	R 1640 sw	R 1641 sw	R 1642 sw	R 1643 sw	R 1644 sw
 2 x 5mm	 2 x 8mm	 2 x 10mm	 3 x 5mm	 3 x 8mm	 3 x 10mm



R 1638	R 1653 sw	R 1645 sw	R 1646 sw	R 1647 sw	R 1648 sw
 3 x 20mm	 4 x 4mm	 4 x 8mm	 4 x 10mm	 4 x 15mm	 4 x 20mm

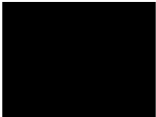

R 1654 sw	R 1649 sw	R 1650 sw	R 1651 sw	R 1652 sw
 5 x 5mm	 5 x 10mm	 5 x 15mm	 5 x 20mm	 5 x 30mm

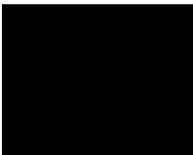

R 1655 sw	R 1551	R 1656 sw	R 1657 sw	R 1659 sw	R 9620 sw
 6 x 6mm	 7 x 20mm	 8 x 8mm	 10 x 10mm	 12 x 10mm	 12 x 12mm

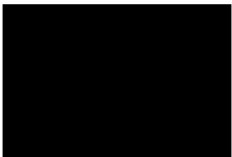
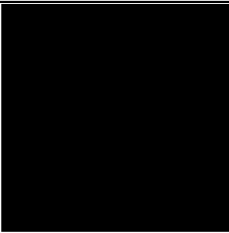

R 9621 sw	R 9622 sw	R 9623 sw	R 9624 sw	R 9625 sw
 15 x 10mm	 15 x 15mm	 15 x 30mm	 20 x 10mm	 20 x 15mm

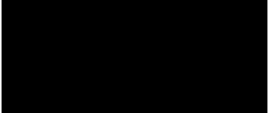

R 9626 sw	R 9627 sw	R 9628 sw	
 20 x 20mm	 25 x 10mm	 25 x 15mm	

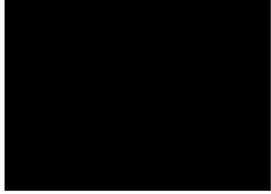

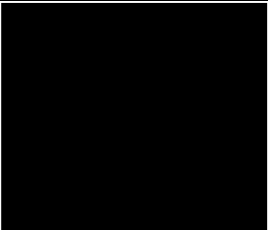
R 9629 sw	R 9630 sw	R 9631
 25 x 20mm	 25 x 25mm	 30 x 10mm

R 9632 sw	R 9633 sw	R 9634
 30 x 20mm	 30 x 30mm	 35 x 10mm

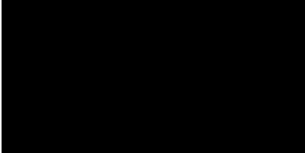
R 9635 sw	R 9636 sw	R 9637 sw
 35 x 15mm	 35 x 20mm	 35 x 25mm

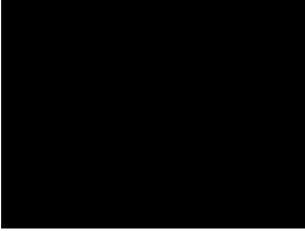

R 9638 sw	R 9639 sw	R 9640 sw
 35 x 30mm	 40 x 10mm	 40 x 15mm



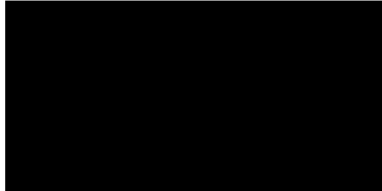

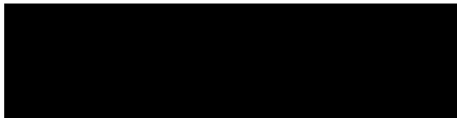

R 9641 sw	R 9642	R 9643 sw
 40 x 20mm	 40 x 25mm	 40 x 30mm



<p>R 9644 sw</p>	<p>R 9645 sw</p>
 <p>40 x 35mm</p>	 <p>40 x 40mm</p>







<p>R 9646 sw</p>	<p>R 9647 sw</p>
 <p>50 x 20mm</p>	 <p>50 x 25mm</p>







<p>R 9648 sw</p>	
 <p>60 x 15mm</p>	







R 1660	R 1881			
 4 x 23mm	 7 x 37mm			







R 1676	R 1678 sw	R 1679 sw	R 1677	R 1680 sw	R 1682 sw
 9 x 5,5mm (1mm)	 10 x 10mm (2mm)	 12 x 12mm (2mm)	 14,5 x 6,5mm (1,5mm)	 15 x 15mm (2,5mm)	 20 x 20mm (3mm)







R 1683 sw	R 1685 sw			
 20 x 20mm (4mm)	 25 x 25mm (5mm)			



R 1600 sw	R 1601 sw	R 1628	R 1602 sw	R 1603 sw	R 1604 sw
 3 x 8mm (1mm / 6mm)	 3 x 10mm (1mm / 8mm)	 3 x 15mm (1mm / 13mm)	 3,5 x 8mm (1,2mm / 6mm)	 3,5 x 10mm (1,2mm / 8mm)	 4 x 8mm (1,5mm / 6mm)

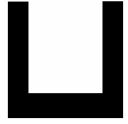



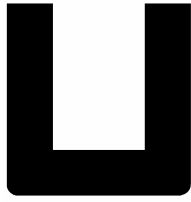

R 1605 sw	R 1606 sw	R 511 sw	R 1607 sw	R 1608 sw	R 1609 sw
 4 x 10mm (1,5mm / 8mm)	 4 x 12mm (1,5mm / 10mm)	 4,8 x 10mm (1,7mm / 8,5mm)	 5 x 10mm (1,8mm / 8mm)	 5 x 12mm (1,8mm / 10mm)	 5 x 10mm (2mm / 8mm)







R 1610 sw	R 1611 sw	R 1612 sw	R 1613 sw	R 1614 sw	R 1615 sw
 5 x 12mm (2mm / 10mm)	 6 x 10mm (2,5mm / 8mm)	 6 x 12mm (2,5mm / 10mm)	 6 x 10mm (3mm / 8mm)	 6 x 12mm (3mm / 10mm)	 8 x 10mm (4mm / 8mm)





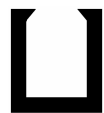

R 1616 sw	R 1625 sw	R 1617 sw	R 1618 sw	R 1619 sw	R 1250 sw
 8 x 12mm (4mm / 10mm)	 10 x 12mm (4mm / 9mm)	 9 x 12mm (5mm / 10mm)	 10 x 10mm (6mm / 8,5mm)	 10 x 12mm (6mm / 10mm)	 10,5 x 10mm (7,5mm / 8,5mm)





R 1620 sw	R 1621 sw	R 1624 sw	R 1622 sw	R 1623 sw	R 1627 sw
 12 x 12mm (8mm / 10mm)	 15 x 12mm (10mm / 9mm)	 15 x 15mm (10mm / 12mm)	 18 x 15mm (12mm / 12mm)	 18 x 18mm (12mm / 15mm)	 22 x 20mm (12mm / 15mm)



R 1626 sw			R 8775 gr	R 8548
 24 x 25mm (12,4mm / 19,2mm)				



R 563 sw	R 1850	R 867	R 1826	R 1032	R 798
					

R 2014	R 1359 sw	R 1362	R 1453	R 1031	R 1252
					

R 1865	R 2064	R 1377	R 2062	R 1351	R 8727
					

R 1216	R 1888	R 8764	R 8512		R 1129
					



R 1839	R 1880	R 1363
		

R 1898	R 2310	
		

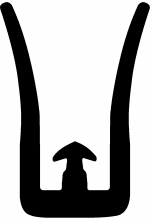
R 1465			R 1834
			

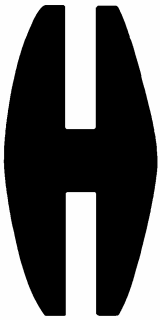

R 8818 sw		
		



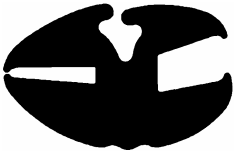
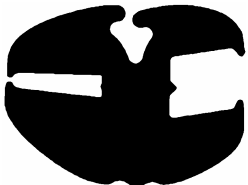

	R 2208
	

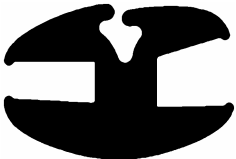



R 2201 sw	R 2203 sw	R 2205 sw
 <p>1,5mm / 3,0mm / Füller R 2239</p>	 <p>4,5mm / 5,0mm / Füller R 2239</p>	 <p>4,0mm / 6,0mm / Füller R 2239</p>

		R 2239 sw
		 <p>Füllerprofil</p>





R 2204 sw	R 2206 sw	R 2207 sw
 <p>2,0mm / 5,0mm / Füller R 2238</p>	 <p>2,5mm / 5,0mm / Füller R 2238</p>	 <p>3,0mm / 8,0mm / Füller R 2238</p>



R 2202 sw		R 2238 sw
 <p>5,5mm / 6,6mm / Füller R 2238</p>		 <p>Füllerprofil</p>

R 100-SK rbr/sw/w	R 102-SK rbr/sw/w	R 103-SK sw/w		R 104-SK br/w	R 105-SK br/w
					

R 106-SK rbr/sw/w	R 108-SK rbr/sw/w		R 101-SK w	R 107-SK sw	R 109-SK sw
					

Sanierungsdichtungen mit Klebeband – Optimal Haftung auf sauberen Oberflächen

SIT 4 br/sw/w	SIT 6 br/sw/w	SIT 8 br/sw/w	SIT 10 br/sw/w		
 <p>4mm-Schlauch 3 – 4mm Nut</p>	 <p>6mm-Schlauch 3 – 4mm Nut</p>	 <p>8mm-Schlauch 3 – 4mm Nut</p>	 <p>10mm-Schlauch 3 – 4mm Nut</p>		

	SIA 6 br/w	SIA 8 br/w	SIA 10 br/w		
	 <p>6mm-Schlauch</p>	 <p>8mm-Schlauch</p>	 <p>10mm-Schlauch</p>		

Schwalbenschwanzfuß auf Anfrage					