

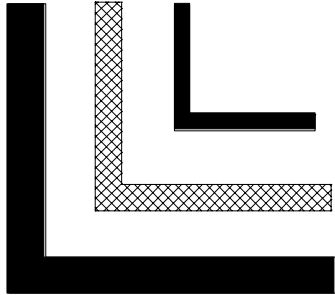

RHIMEX



**Profiles of rubber, sponge rubber,
silicone, foam silicone**

angle profiles

Solid rubber

Legend

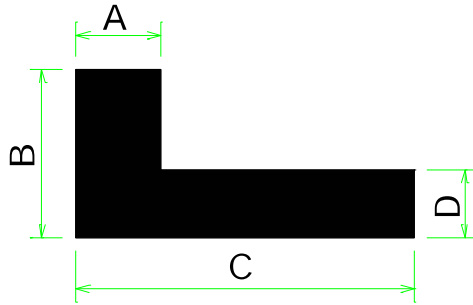

9999

means

Profile-No.

EP / s / 9999 / (9998)

means Quality / Colour / Article-No. / (Article-No. with sa)

sa = self adhesive

Quality

CR	Neoprene
EP	EPDM
NBR	Perbunan
NK	Natural rubber
Si	Silicone
SPS	Foam silicone
FPM	VITON®
PVC	Soft-PVC
EVA	Ethylenvinylacetat
SBR	Buna (Styrol-Butadien)
-FR	fire resistant

Colours

s	black
g	grey
w	white
az	anthracite
bg	beige
br	brown
hg	light-grey
rb	red-brown
t	translucent
r	red
x	colour selectable

® = Entered registered trade mark of the company DuPont

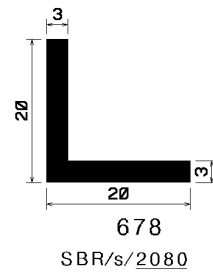
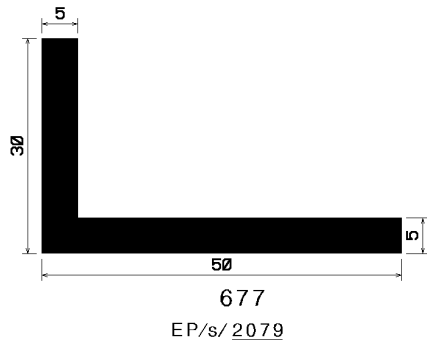
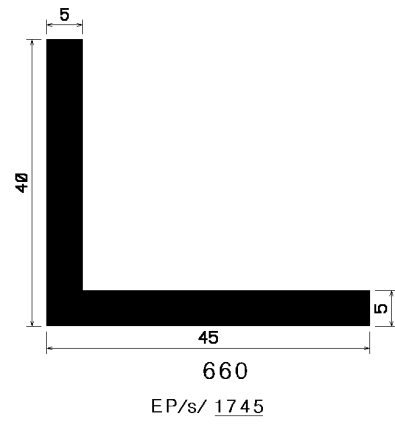
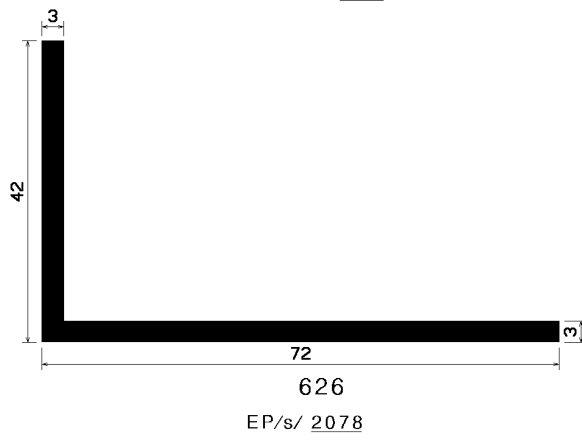
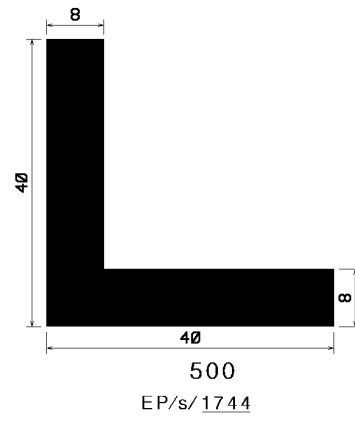
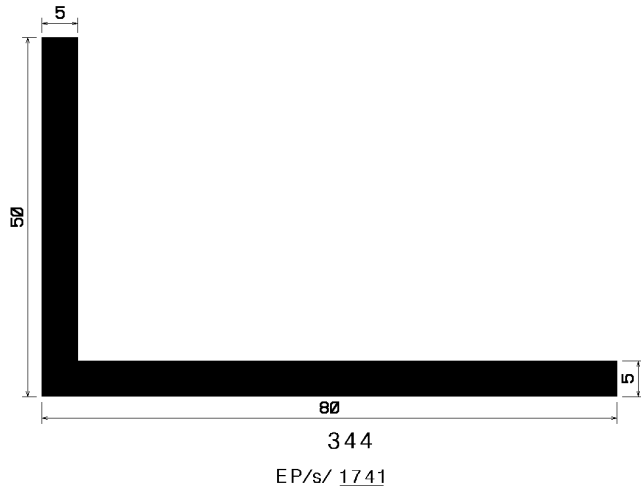
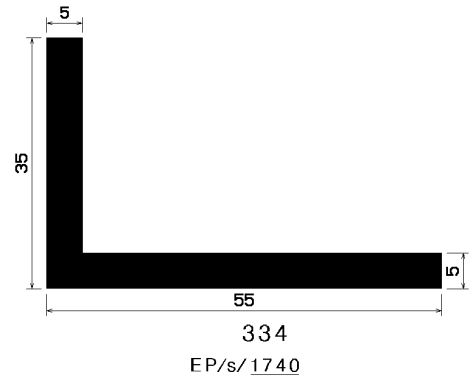
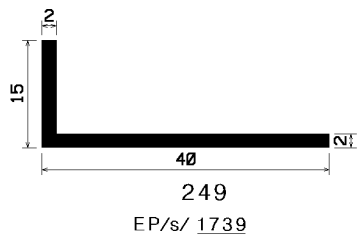

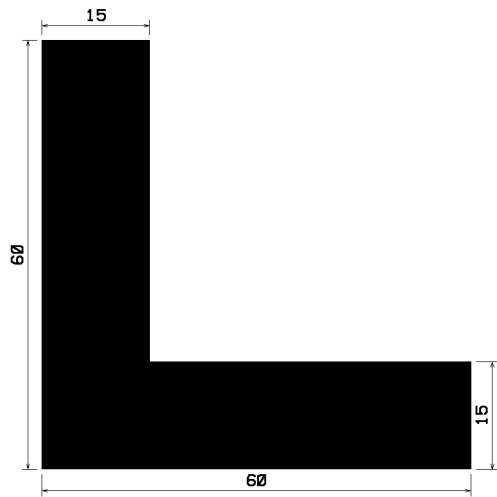

682
EP/s/ 2081

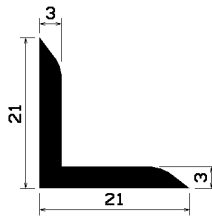

683
EP/s/ 2082

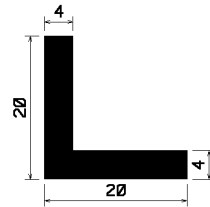

684
NBR/s/2083

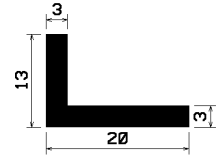

685
EP/s/ 4058
NK/w/2084

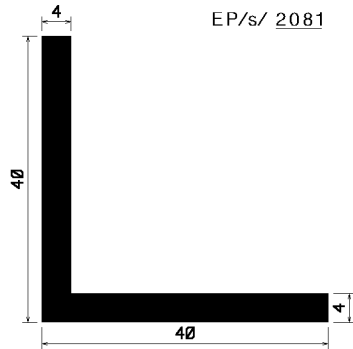

686
EP/s/ 2085

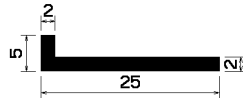

687
CR/s/2086

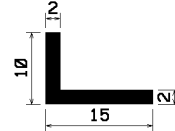

688
EP/s/ 2087/(4870)

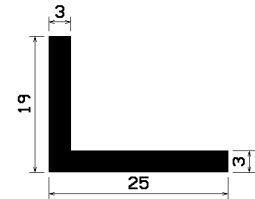

691
EP/s/ 2905/(5098)

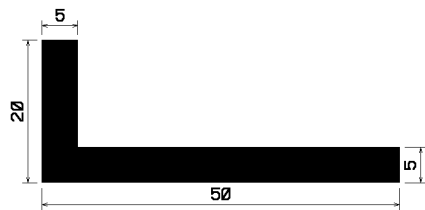

747
EP/s/ 2194

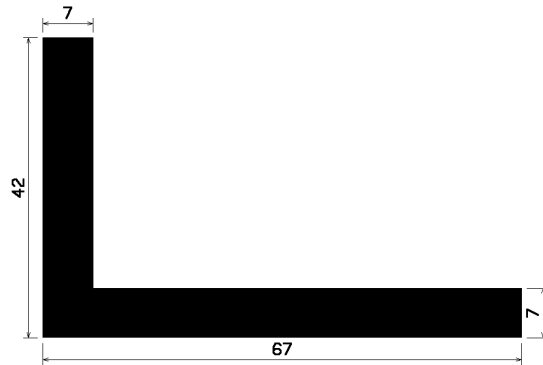

776
EP/s/ 2444

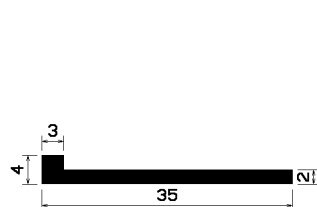

823
EP/s/ 2672

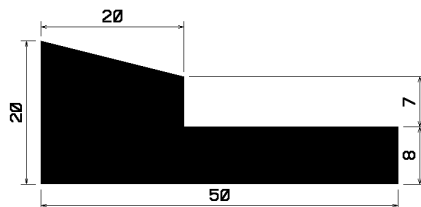

908
EP/s/ 3088

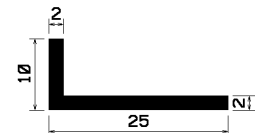

911
EP/s/ 3092

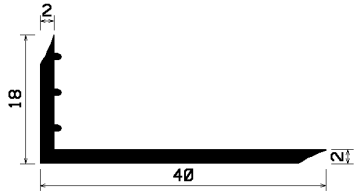

1072
Si/g/ 3497

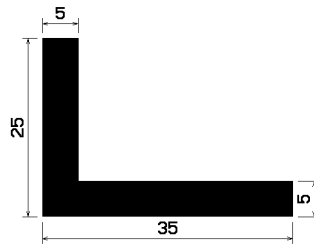

1186
EP/s/ 1743

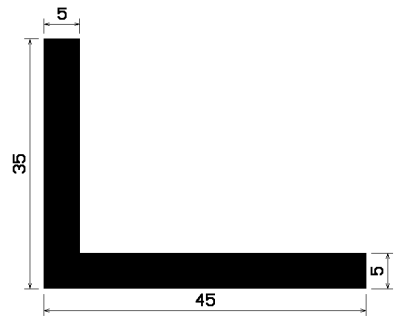

1197
EP/s/ 1742

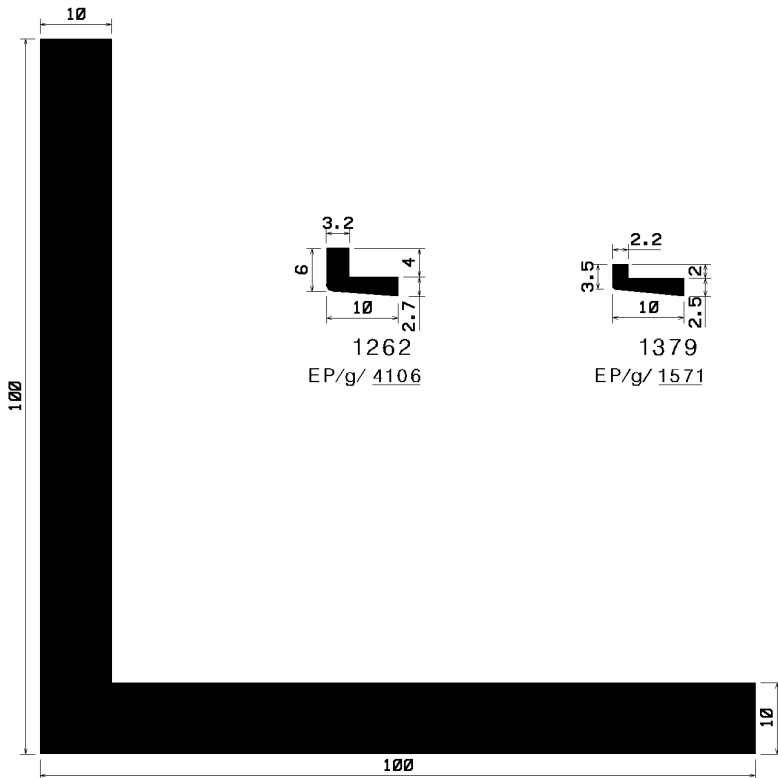

1509
EP/s/ 4696

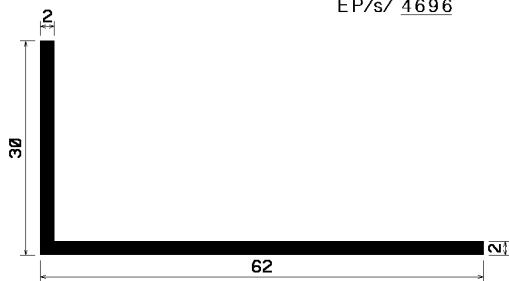

1691
EP/s/ 5762

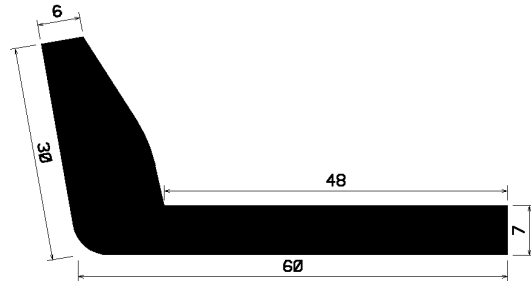

1747
EP/s/ 5988

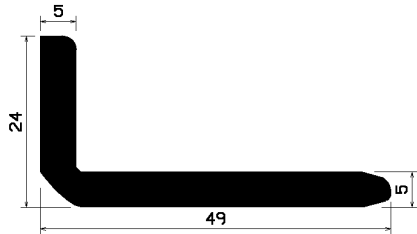

1791
Si/I/ 6088

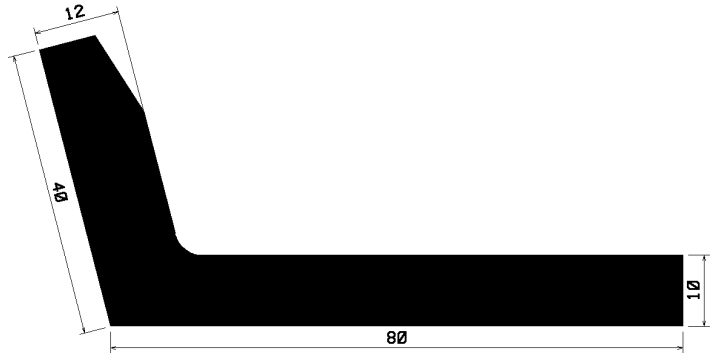

1798
EP/s/ 6108

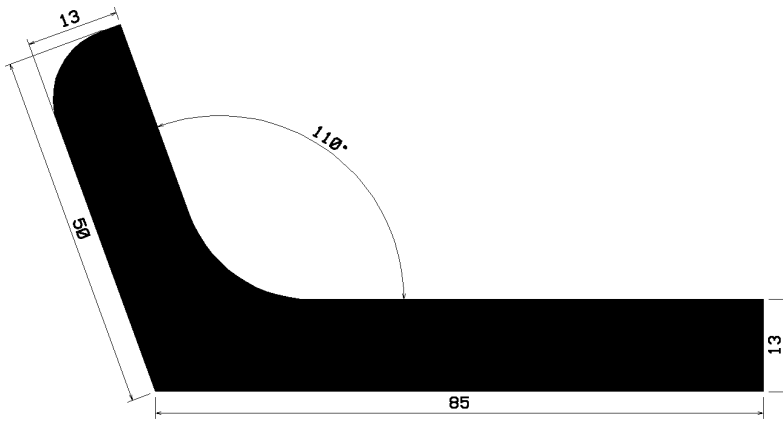

1855
EP/s/ 6448

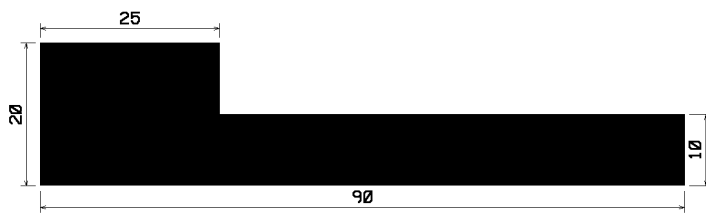

1863
EP/s/ 6544

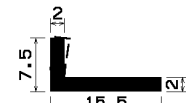

1895
Si/I/ 6590

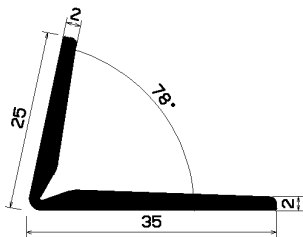

1901
Si/s/ 6622

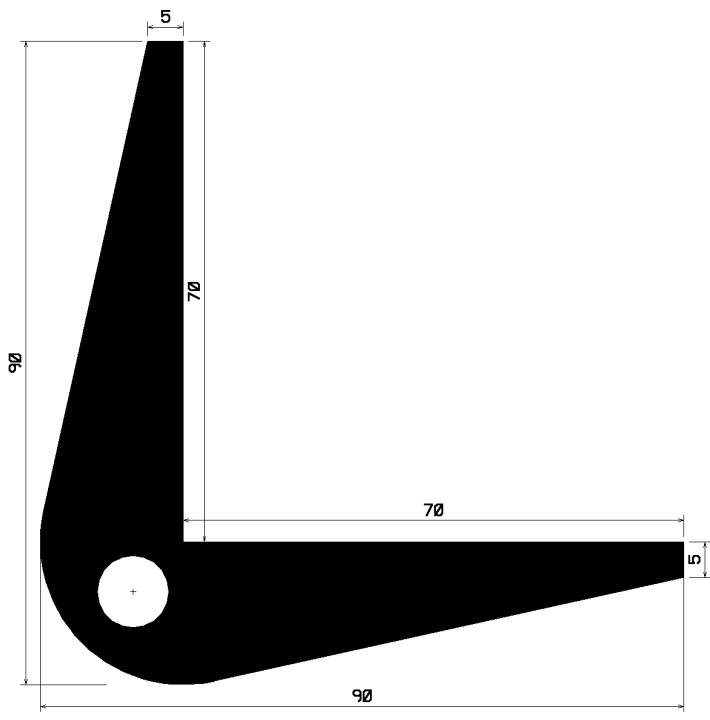

1963
EP/s/ 6871

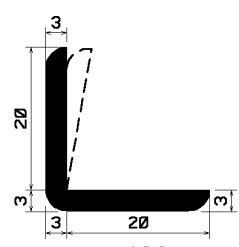

1994
EP/s/ 6975

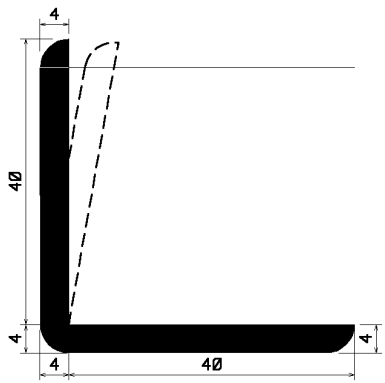

1996
EP/s/ 6974

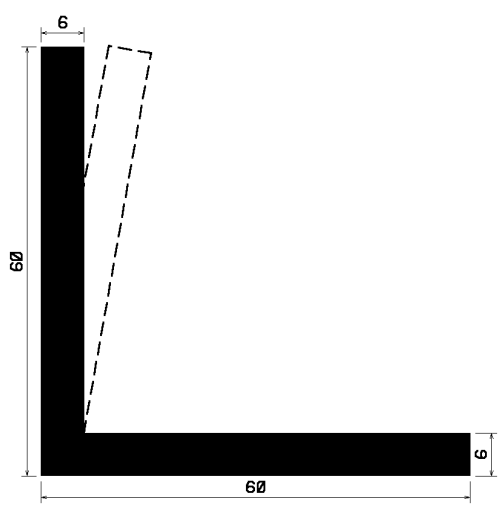

2059
EP/s/ 7158

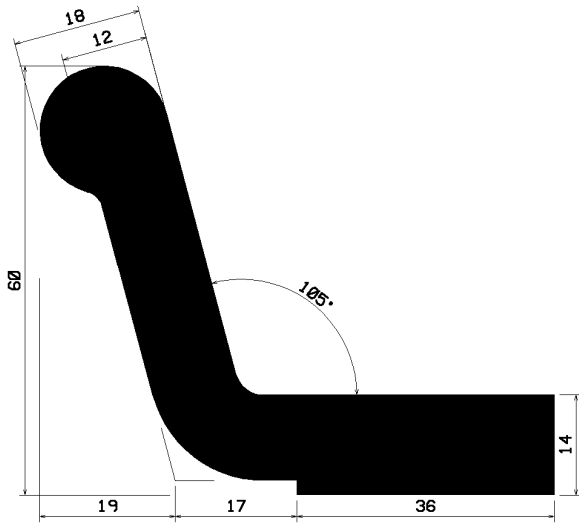

2067

NR/SBR/s/ 7168

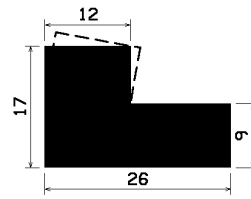

2170

EP/s/ 7620

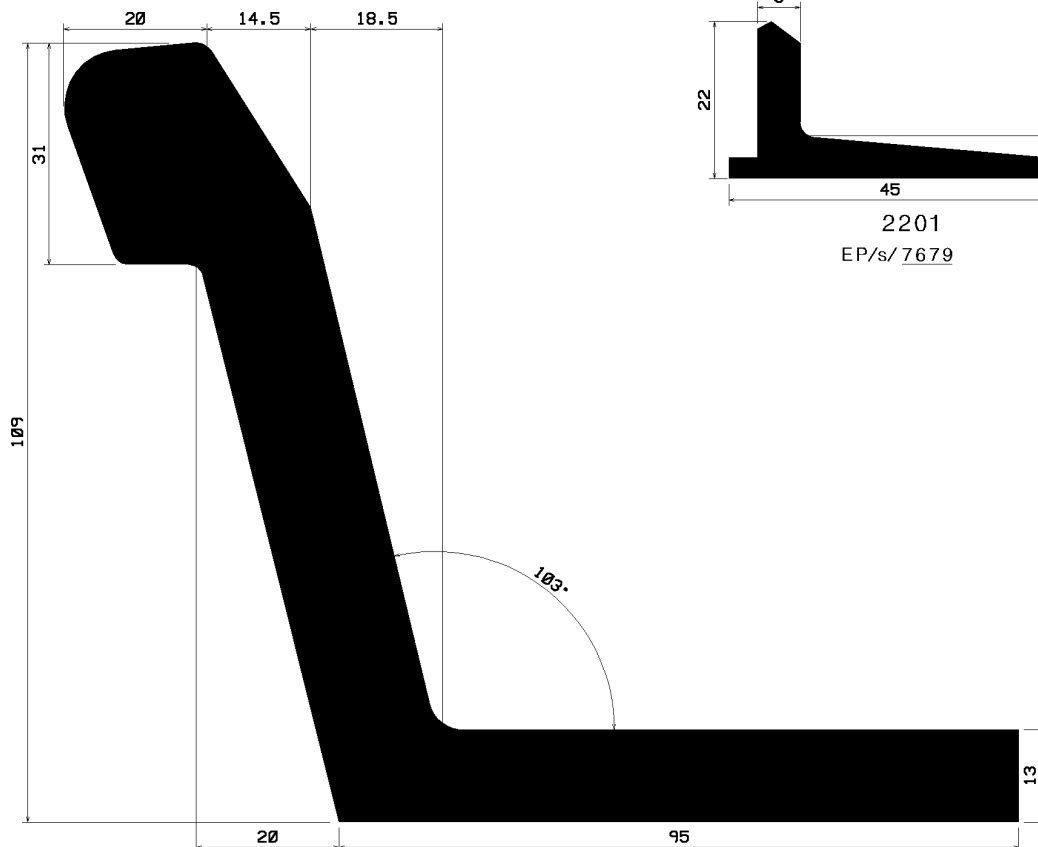

2267

EP/s/ 7941

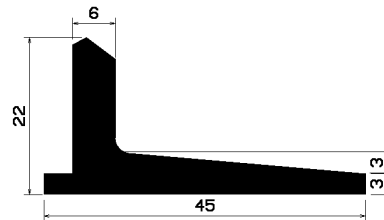

2201

EP/s/ 7679

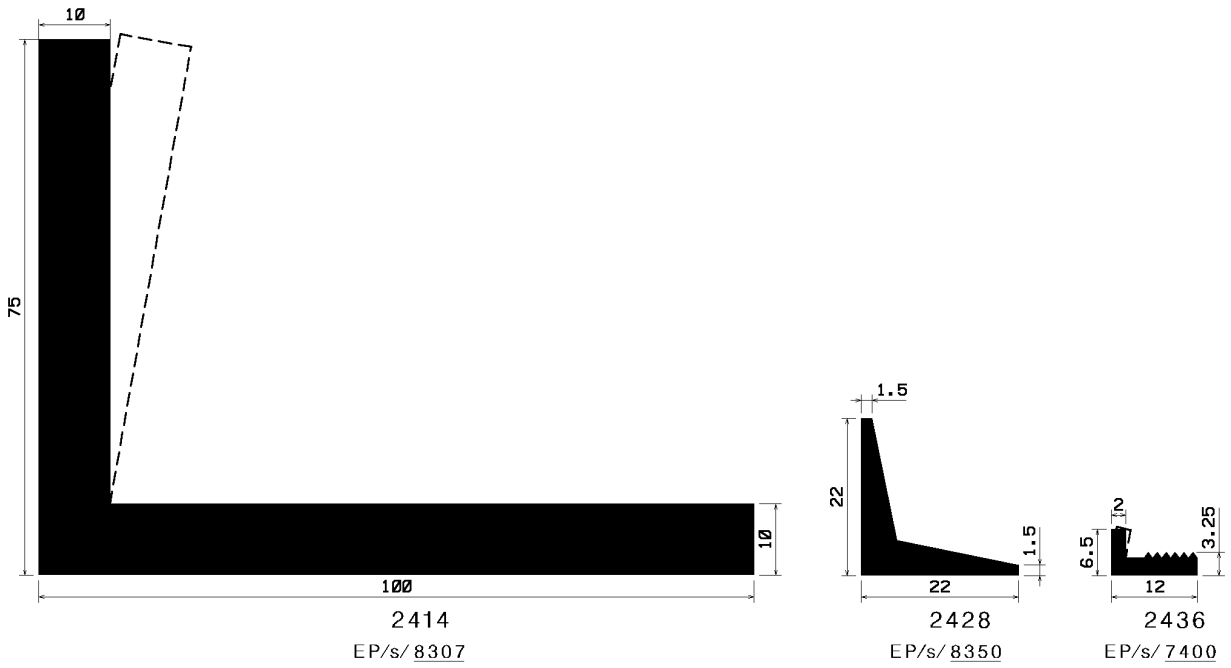
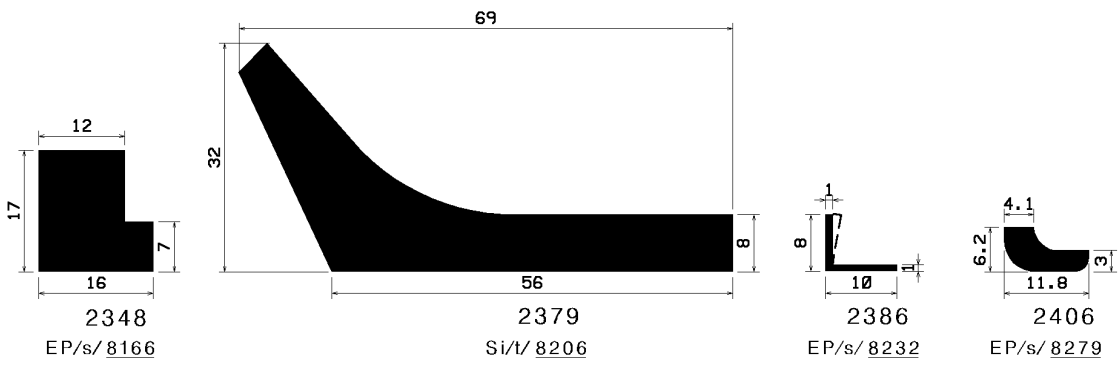
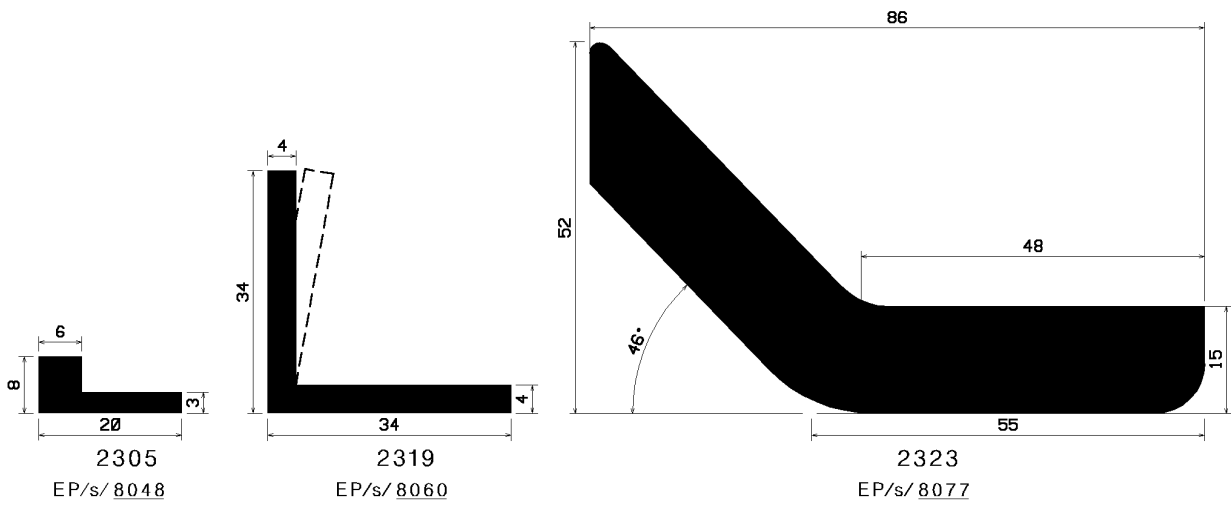

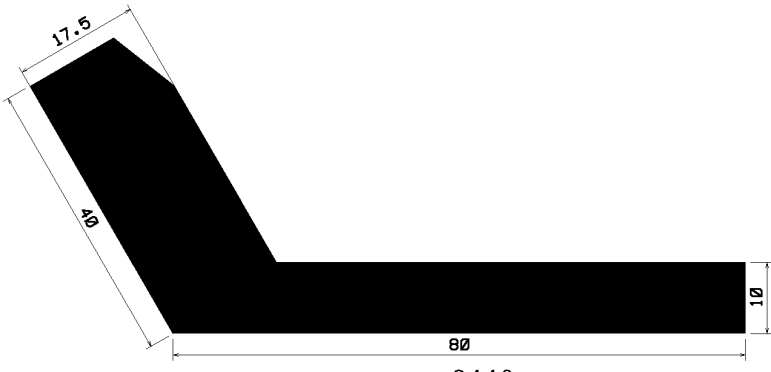

2440
EP/s/7406

Sponge rubber

Legend

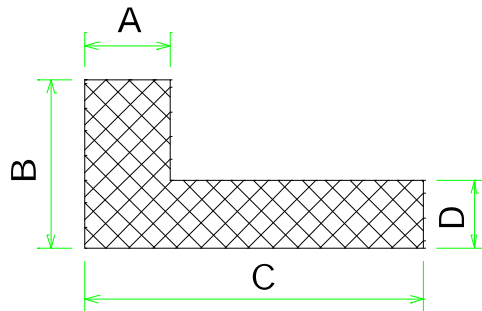

25999

means

Profile-No.

EP / s / 9999 / (9998)

means

Quality / Colour / Article-No. / (Article-No. with sa)

sa = self adhesive

Quality

CR	Neoprene
EP	EPDM
NBR	Perbunan
NK	Natural rubber
Si	Silicone
SPS	Foam silicone
FPM	VITON®
PVC	Soft-PVC
EVA	Ethylenvinylacetat
SBR	Buna (Styrol-Butadien)
-FR	fire resistant

Colours

s	black
g	grey
w	white
az	anthracite
bg	beige
br	brown
hg	light-grey
rb	red-brown
t	translucent
r	red
x	colour selectable

® = Entered registered trade mark of the company DuPont

Sponge rubber

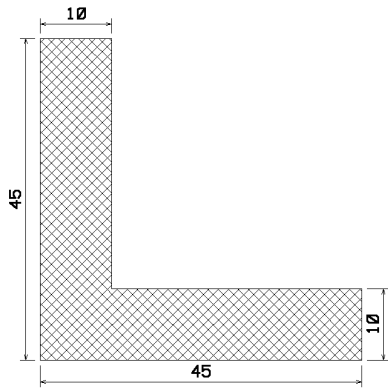

25018
EP/s/ 0278

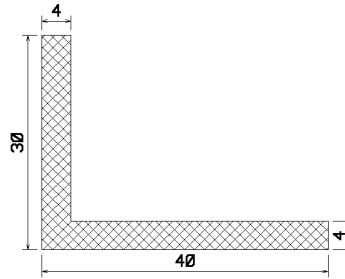

25041
EP/s/ 0300

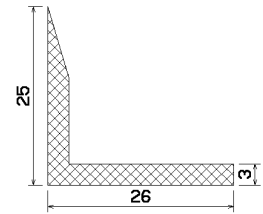

25064
EP/s/ 0320

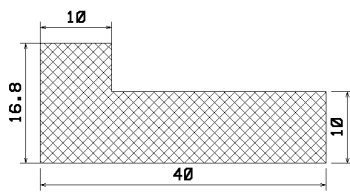

25148
EP/s/ 0401

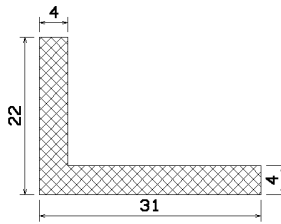

25151
EP/s/ 0404

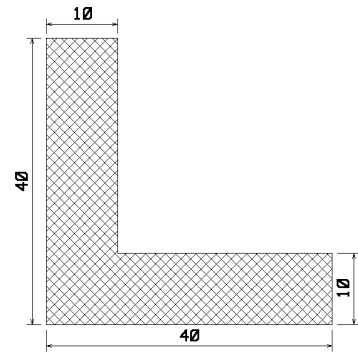

25163
EP/s/ 1260/(4394)

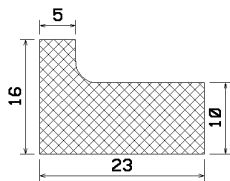

25193
EP/s/ 2067

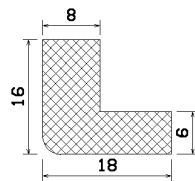

25244
EP/s/ 2998

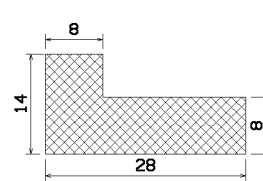

25259
EP/s/ 3068

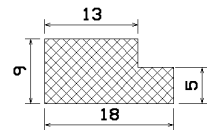

25276
CR/g/ 3255
CR/rb/ 4136

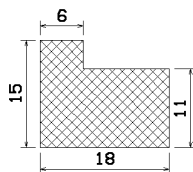

25321
CR/s/ 3589

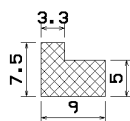

25331
EP/g/ 3650

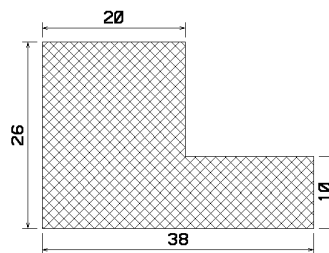

25332
EP/s/ 3656

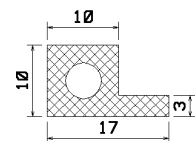

25363
CR-FR/s/ 3872

Sponge rubber

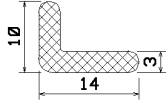

25586

CR/s/ 5091

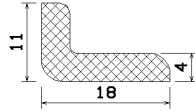

25587

CR/s/ 5092

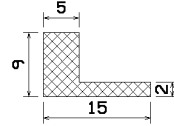

25637

EP/s/ 4588

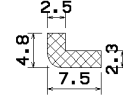

25652

EP/g/ 4742

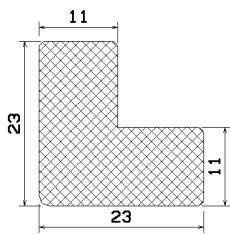

25783

EP/s/ 7555

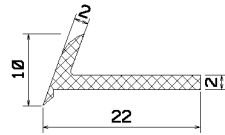

25802

EP/s/ 8253