

**Profiles of rubber, sponge rubber,
silicone, foam silicone**

buffer profiles

last modification: 12.08.2006

BP

Solid rubber or Soft-PVC

Legend

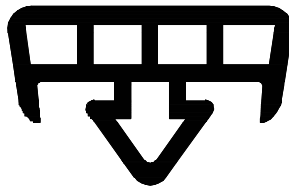

9999

means

Profile-No.

EP / s / 9999

means

Quality / Colour / Article-No

Quality

CR	Neoprene
EP	EPDM
NBR	Perbunan
NK	Natural rubber
Si	Silicone
SPS	Foam silicone
FPM	VITON®
PVC	Soft-PVC
EVA	Ethylenvinylacetat
SBR	Buna (Styrol-Butadien)

Colours

s	black
g	grey
w	white
az	anthracite
bg	beige
br	brown
hg	light-grey
rb	red-brown
t	translucent
r	red
x	colour selectable

® = Entered registered trade mark of the company DuPont

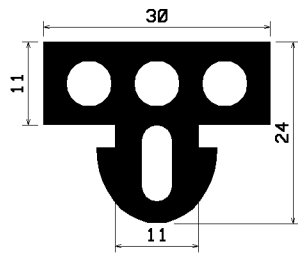

139
EP/s/ 1620
NK/w/1621

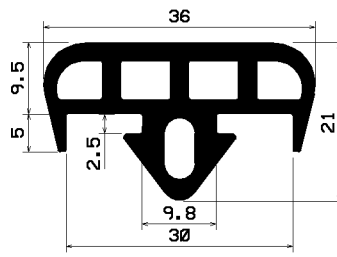

140
EP/s/ 1619
EP/w/ 3956

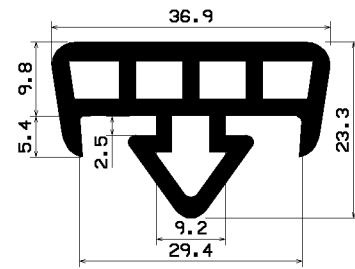

140/1
EP/s/ 6035

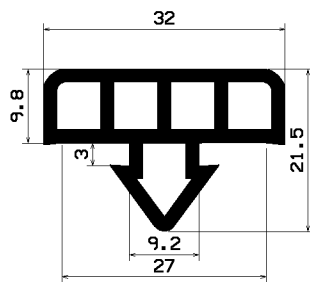

140/2
EP/s/ 6489

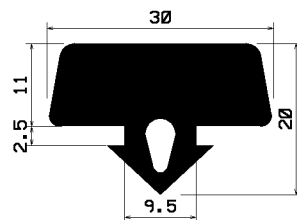

319
EP/s/ 3346
Si/t/ 7671

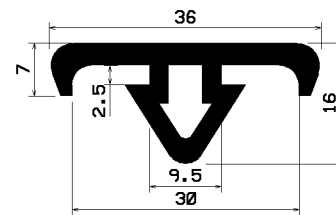

1131
EP/s/ 3740

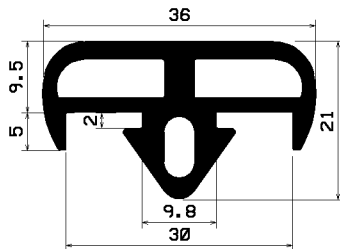

1528
EP/s/ 4883

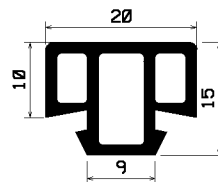

1531
EP/g/ 4761

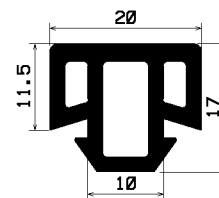

1549
EP/g/ 4803

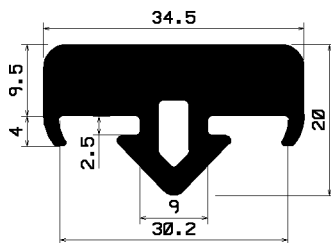

1583
EP/s/ 5784

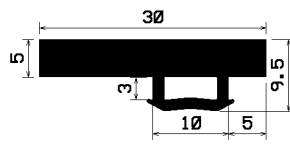

1690
EP/s/ 5748

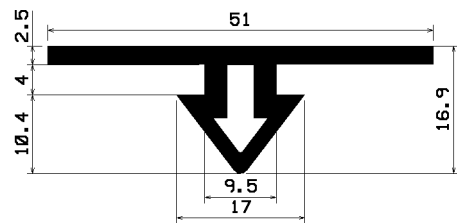

1938
Si/t/ 6672

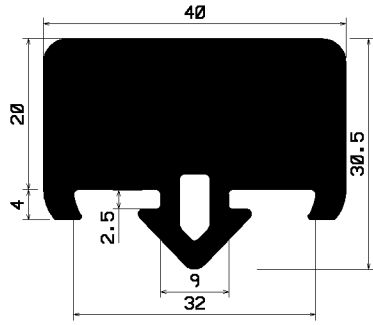

2103
EP/s/ 7280

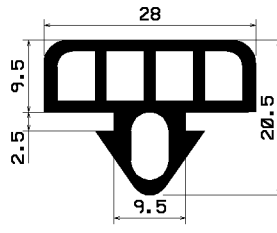

2324
EP/s/ 8072